

# Office 5

SYSTÈME  
DE MOBILIER  
DE BUREAU  
VERSATILE

VERSATILE  
OFFICE  
FURNITURE  
SYSTEM

  
artelite



LISTE DE PRIX 2016 PRICE LIST



---

Descriptions et finis - <i>Specifications and finishes</i>	4
Exemples de configuration - <i>Planning possibilities</i>	6
Bureaux et tables - <i>Desks and tables</i>	8
Retours - <i>Returns</i>	10
Bahuts - <i>Credenzas</i>	13
Modules de rangement - <i>Storage units</i>	17
Huches autoportantes - <i>Overhead cabinets and hutches</i>	20
Huches murales - <i>Wallmounted hutches</i>	22
Tours latérales au sol - <i>Lateral freestanding towers</i>	24
Armoires - <i>Bookcases</i>	25
Système de base et pattes - <i>Base system and legs</i>	28
Modules de rangement superposables- <i>Stackable storage units</i>	29
Tables et tabourets - <i>Tables and stools</i>	34
Accessoires - <i>Accessories</i>	35
Conditions de vente - <i>Conditions of sale</i>	37

---

**Bureaux**

Les bureaux sont disponibles en deux versions:

Le style **TD**: table de travail avec pattes Signature Office 5 en "V" - panneau de modestie.

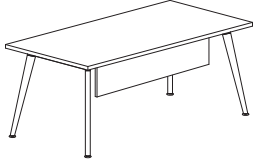

Le style **O5**: bureau standard simple ou double caissons - panneau de modestie.

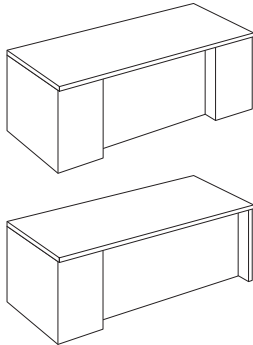

Les bureaux sont tous équipés de niveleurs.

**Surfaces de travail**

Les surfaces de travail de 1<sup>3</sup>/<sub>16</sub>" d'épaisseur sont pourvues d'une bordure en bois massif.

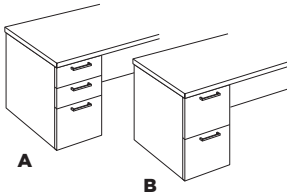
**Caissons****Bahuts**

Les bahuts sont assemblés mais des configurations particulières peuvent être créées à partir d'un choix de composantes modulaires.

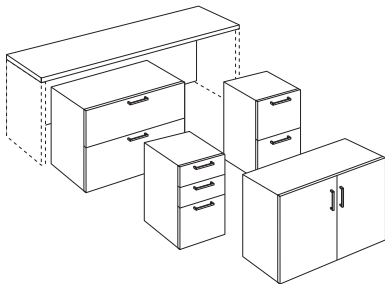

Les modules de rangement superposables sont disponibles avec le système de base Office 5 (voir page 28).

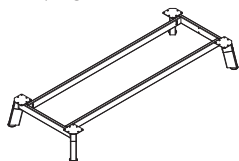
**Finis**

La présente liste de prix indique des prix correspondants aux finis du grade 1. Pour un fini optionnel, ajoutez au prix de liste le pourcentage d'augmentation indiqué au grade désiré :

**Grade 1** (prix de liste)

ESSENCE DE BOIS

Noyer  
Cerisier  
Chêne  
Érable  
Frêne  
Frêne Quartier  
Cerisier Quartier

**Prix de liste****Grade 2** (ajouter 10% au prix de liste)

ESSENCE DE BOIS      % EN PLUS

Anigre  
Wenge  
Sapeli  
Érable Figuré  
Noyer Quartier

**+ 10%**

Consultez les cartes d'échantillons des finis de bois afin d'obtenir le code des finis disponibles et ajoutez ce code à la suite du code du meuble désiré.

Un fini optionnel peut être appliqué. Prix sur demande.

**Poignée Office 5**

**Fin** : nickel brossé

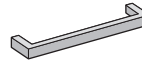
**Option - porte vitrée**

Les portes pleines des modules de rangement peuvent être remplacées, en option, par des portes vitrées.

Des vitres teintées ou autres sont également disponibles en option. Prix sur demande.

**Bordure**

Les surfaces des meubles sont munies d'une bordure de bois massif de 1<sup>3</sup>/<sub>16</sub>" d'épaisseur:

TYPE	BORDURE
<b>O5</b>	

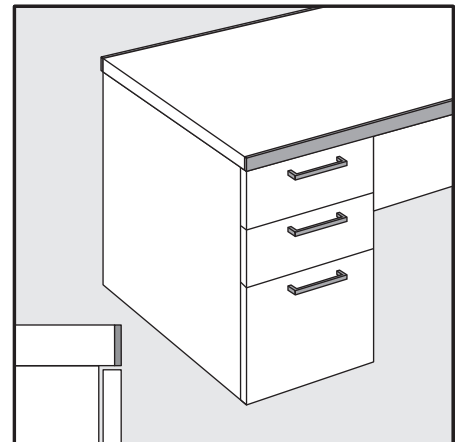
**Bordure Office 5 - standard****Note**

Toutes les dimensions des surfaces indiquées sont nominales.

**Desks**

The desks are available in two versions :

**TD style** : table desk with Office 5 Signature "V" leg and modesty panel.

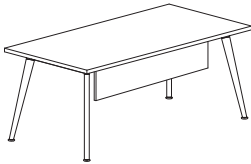

**O5 style** : straight top - straight front, single or double pedestal with full modesty panel.

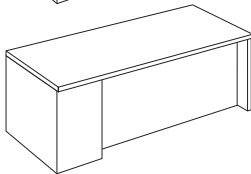
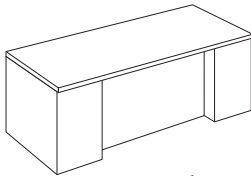

All desks are equipped with levellers.

**Work surfaces**

The 1<sup>3</sup>/<sub>16</sub>" thick work surfaces are provided with solid wood edges.

**Pedestals**

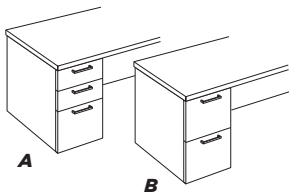

**Credenzas**

The credenzas are assembled but particular configurations can be created from a choice of modular options.

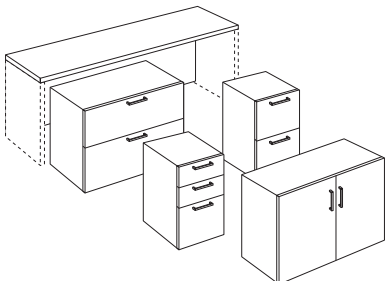

Stackable storage units are available with Office 5 base system (see p. 28).

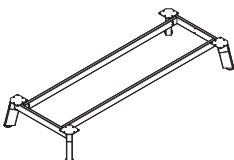

**Finishes**

The price list shows Grade 1 prices. Optional finishes and veneers are subject to increase shown below determined by wood species and finishes :

**Grade 1** (list price)

WOOD SPECIES

- Walnut
- Cherry
- Oak
- Maple
- Ash
- Quartered Ash
- Quartered Cherry

**Prix de liste**

**Grade 2** (add 10% to list price)

WOOD SPECIES                      % TO ADD

- Anigre
- Wenge
- Sapele
- Figured Maple
- Quartered Walnut

**+ 10%**

Consult the sample cards in your catalogue to specify the available finish code and add this code immediately after the furniture code.

Optional finishes are available on request as an option.

**Office 5 handle**

**Finish:** brushed nickel

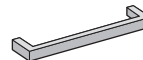

**Option - glass doors**

The full doors of storage units can be replaced by optional clear glass doors.

Optional tinted glass or others are also available. Price on request.

**Edge**

Work surfaces are equipped with a 1<sup>3</sup>/<sub>16</sub>" thick solid wood edges :

TYPE	EDGE
<b>O5</b>	

**Standard Office 5 edge**

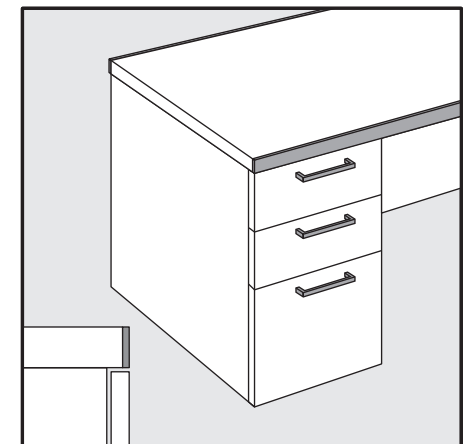

**Note**

All indicated top dimensions are approximate.

Les prix indiqués dans les exemples suivants sont basés sur les prix du fini de bois grade 1 avec finition standard.

Référez-vous à la liste de prix pour les différentes grandeurs et options disponibles.

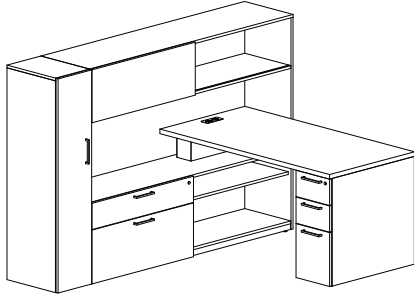

### CONFIGURATION 1

Retour droit avec caisson utilité 12" et modestie de 6". <i>Right return with 12" utility pedestal and 6" modesty panel.</i>	1x <b>O5-ERR-RZ1-7236-A12-MP6</b>	2 300 \$
Crédence avec caisson utilité-filière et armoire ouverte. <i>Credenza with box-file pedestal and open bookcase.</i>	1x <b>O5-CLZ-7218-OLZ</b>	2 890 \$
Armoire penderie, gauche. <i>Left wardrobe unit.</i>	1x <b>O5-1SL-18</b>	1 770 \$
Huche autoportante semi-ouverte avec porte coulissante. <i>Freestanding semi-closed hutch with sliding door.</i>	1x <b>O5-OCPC-3572-18</b>	2 130 \$
Babillard pour huche. <i>Tackboard for hutch.</i>	1x <b>AC-TK-72</b>	440 \$
Module électrique avec 2 simplexes et prise USB double. <i>Power module with 2 simplexes and double USB port.</i>	1x <b>AC-ECC-2</b>	525 \$
		<b>10 055 \$</b>

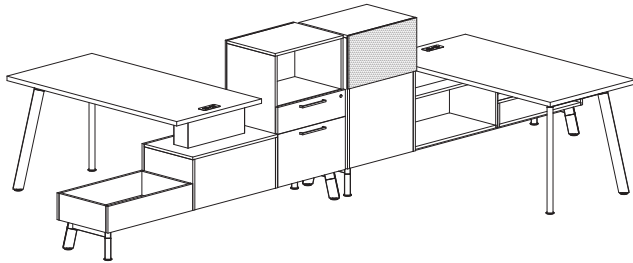

### CONFIGURATION 3

Table de travail avec patte de bois O5 et espaceur. <i>Work table with O5 wood legs and riser.</i>	2x <b>O5-TD-V-6630-RZ2-W</b>	3 040 \$
Petite armoire superposable, ouverte, utilité-filière. <i>Small stackable open bookcase with box-file drawers.</i>	2x <b>O5-O13-2435-18</b>	3 620 \$
Huche superposable avec porte coulissante. <i>Stackable hutch with sliding door.</i>	1x <b>O5-WCSD-1436-18</b>	1 120 \$
Bac à fleur, 7" de haut. <i>Planter, 7" H.</i>	1x <b>O5-PLTR-3018</b>	470 \$
Huche superposable, ouverte. <i>Open stackable hutch.</i>	1x <b>O5-WCO-1436-18</b>	910 \$
Module de huche ouverte superposable, 7" de haut. <i>Open stackable hutch module, 7" H.</i>	1x <b>O5-WCI-0730-18</b>	400 \$
Coussin, grade 1 ou C.O.M. <i>Cushion, grade 1 or C.O.M.</i>	1x <b>O5-SEAT-3018</b>	325 \$
Babillard. <i>Tackboard.</i>	2x <b>AC-TK-2414</b>	600 \$
Base avec pattes de bois pour modules superposables. <i>Base for stackable units with wood legs.</i>	2x <b>O5-BASE-8418-W</b>	1 540 \$
Module électrique avec 2 simplexes et prise USB double. <i>Power module with 2 simplexes and double USB port.</i>	2x <b>AC-ECC-2</b>	1 050 \$
		<b>13 115 \$</b>

All prices in the examples below are based on grade 1 veneer and standard finish.

Refer to price list for other options and different dimensions.

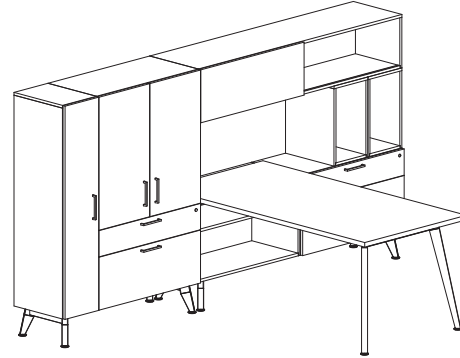

### CONFIGURATION 2

Table de travail avec patte O5 en bois à gauche. <i>Work table with O5 wooden leg on left.</i>	1x <b>O5-TD-V-7230</b>	1 460 \$
Crédence superposable avec armoire ouverte et caisson utilité-filière. <i>Stackable credenza with open bookcase and box-file pedestal.</i>	1x <b>O5-OLZ-7218-CLZ</b>	2 890 \$
Armoire penderie superposable, gauche. <i>Stackable, left wardrobe unit.</i>	1x <b>O5-ST-1SL-1856</b>	1 170 \$
Armoire fermée-caisson utilité filière superposable. <i>Closed bookcase-box-file unit, stackable.</i>	1x <b>O5-C13-3056-18</b>	2 350 \$
Huche autoportante semi-ouverte avec porte coulissante. <i>Freestanding semi-closed hutch with sliding door.</i>	1x <b>O5/OCPC-3572-18</b>	2 130 \$
Babillard pour huche. <i>Tackboard for hutch.</i>	1x <b>AC-TK-48</b>	400 \$
Boîte pigeonnier. <i>Open paper cubbies.</i>	2x <b>O5-ST-SO-1221-18</b>	1 400 \$
Base avec pattes de bois pour modules superposables. <i>Base for stackable units with wooden legs.</i>	1x <b>O5-BASE-4818-W</b>	710 \$
Base avec pattes de bois pour modules superposables. <i>Base for stackable units with wooden legs.</i>	1x <b>O5-BASE-7218-W</b>	740 \$
		<b>13 250 \$</b>

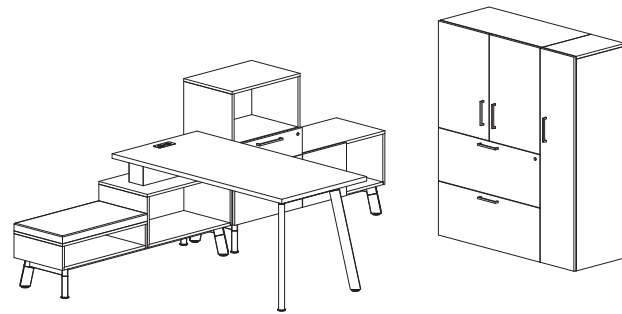

### CONFIGURATION 4

Table de travail avec patte de bois O5 et espaceur. <i>Work table with O5 wood legs and riser.</i>	1x <b>O5-TD-V-6636-RZ2-W</b>	1 610 \$
Petite armoire superposable, ouverte, utilité-filière. <i>Small stackable open bookcase with box-file drawers.</i>	1x <b>O5-O13-3035-18</b>	1 900 \$
Huche superposable avec porte coulissante. <i>Stackable hutch with sliding door.</i>	1x <b>O5-WCPC-1436-18</b>	1 160 \$
Huche superposable, ouverte. <i>Open stackable hutch.</i>	1x <b>O5-WCO-1436-18</b>	910 \$
Huche intermédiaire ouverte, 7" de haut. <i>Intermediate open hutch, 7" high.</i>	1x <b>O5-WCI-0730-18</b>	400 \$
Coussin, grade 1 ou C.O.M. <i>Cushion, grade 1 or C.O.M.</i>	1x <b>O5-SEAT-3018</b>	325 \$
Base avec pattes de bois pour modules superposables. <i>Base for stackable units with wood legs.</i>	2x <b>O5-BASE-6618-W</b>	1 460 \$
Module électrique avec 2 simplexes et prise USB double. <i>Power module with 2 simplexes and double USB port.</i>	1x <b>AC-ECC-2</b>	525 \$
Demi-armoire penderie, droite. <i>Right half-wardrobe unit.</i>	1x <b>O5-1SR-18</b>	1 770 \$
Armoire fermée - classeur latéral, 1 tablette réglable. <i>Closed bookcase - lateral file, 1 adjustable shelf.</i>	1x <b>O5-13L-18</b>	2 540 \$
		<b>12 600 \$</b>

Les prix indiqués dans les exemples suivants sont basés sur les prix du fini de bois grade 1 avec finition standard.

Référez-vous à la liste de prix pour les différentes grandeurs et options disponibles.

All prices in the examples below are based on grade 1 veneer and standard finish. Refer to price list for other options and different dimensions.

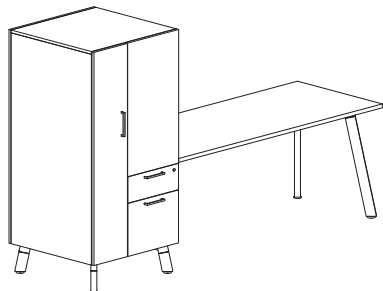

### CONFIGURATION 5

Table de travail avec patte de métal O5.  
Work table with O5 metal legs.

1x **O5-TD-7230-V-M** 1 460 \$

Tour latéral penderie.  
Stackable lateral wardrobe tower.

1x **O5-ST-30RHC-30-M** 3 620 \$

**5 080 \$**

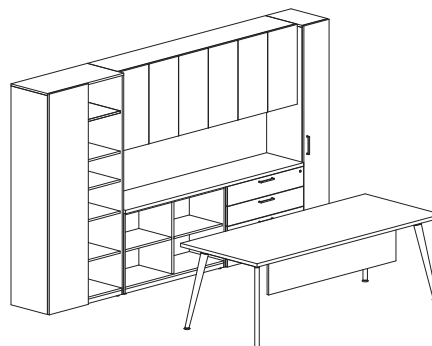

### CONFIGURATION 6

Table de travail avec pattes O5 en bois et demi-modestie.  
Work table with wood O5 legs and half modesty panel.

1x **O5-TD-V-8436-V-MPS** 2 750 \$

Armoire ouverte double.  
Double open bookcase.

1x **O5-OL-4818-28** 1 480 \$

Filière 3 tiroirs.  
3 drawer file.

1x **O5-AL36-18-28** 1 950 \$

Dessus commun pour composer bahut.  
Common top for credenza.

1x **O5-TOP-8418** 980 \$

Huche murale avec portes à charnières.  
Wall mounted hutch with hinged doors.

1x **O5-WCH-2884-15** 2 060 \$

Babillard, Grade 1 ou C.O.M.  
Tackboard, Grade 1 or C.O.M.

1x **AC-TK-84** 495 \$

Armoire semi-ouverte avec porte coulissante.  
Half-closed bookcase with sliding door.

1x **O5-8PCLH-18** 2 500 \$

Armoire penderie droite.  
Right wardrobe.

1x **O5-1SRH-18-18** 1 830 \$

**14 045 \$**

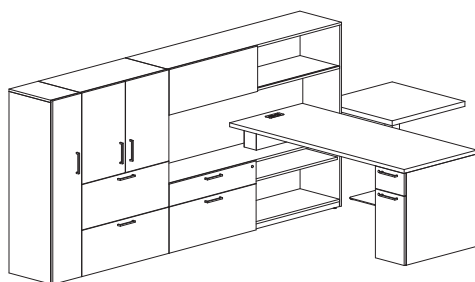

### CONFIGURATION 7

Retour droit avec caisson CPU 12" et modestie de 6".  
Right return with 12" CPU unit and 6" modesty panel.

1x **O5-ERR-RZ1-7236-H12** 2 250 \$

Crédence superposable avec caisson utilité-filière et armoire ouverte.  
Stackable credenza with box-file pedestal and open bookcase.

1x **O5-CLZ-7218-OLZ** 2 890 \$

Armoire penderie, gauche.  
Left wardrobe unit.

1x **O5-1SLM-18** 1 800 \$

Armoire fermée-classeur latéral.  
Closed bookcase-lateral file.

1x **O5-13M-18** 2 570 \$

Huche autoportante semi-ouverte avec porte coulissante.  
Freestanding semi-closed hutch with sliding door.

1x **O5-OCPC-4272-18** 2 330 \$

Table de réunion carrée avec base de métal fini argent.  
Square meeting table with silver metal base.

1x **O5-OT-S-3030-S** 765 \$

Babillard pour huche.  
Tackboard for hutch.

1x **AC-TK-72** 440 \$

Module électrique avec 2 simplexes et prise USB double.  
Power module with 2 simplexes and double USB port.

1x **AC-ECC-2** 525 \$

**13 570 \$**

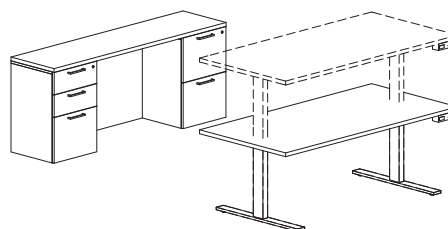

### CONFIGURATION 8

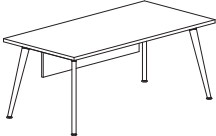
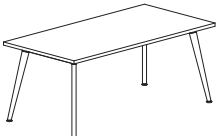

Table de travail rectangulaire à hauteur ajustable.  
Height adjustable table desk with rectangular top.

1x **O5-TD-ADJ-7236** 2 875 \$

Bahut double caisson.  
Kneespace credenza with 2 pedestals.



1x **O5-AL-7218-BL** 3 370 \$

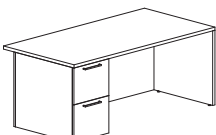
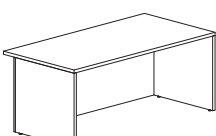
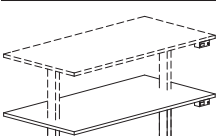

**6 245 \$**

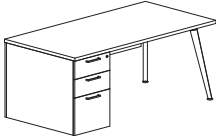
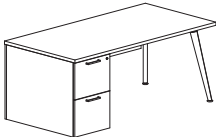
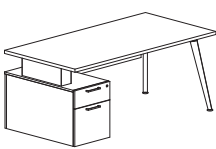
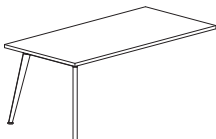
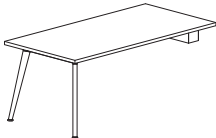
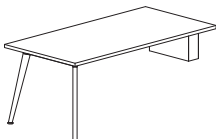
MODÈLE MODEL	DESCRIPTION	CODE	LARG. WIDTH "	PROF. DEPTH "	HAUT. HEIGHT "	POIDS WEIGHT LBS LBS	VOLUME VOLUME PI <sup>3</sup> FT <sup>3</sup>	BOIS WOOD \$
	Table de travail rectangulaire avec piètement O5 en bois et modestie court.  <i>Table desk with wooden O5 legs, rectangular top and short modesty panel.</i>	<b>O5-TD-V-8436-V-MPS</b>	84	36	29	250	60	<b>2750</b>
		<b>O5-TD-V-7836-V-MPS</b>	78	36	29	225	55	<b>2620</b>
		<b>O5-TD-V-7236-V-MPS</b>	72	36	29	205	51	<b>2430</b>
		<b>O5-TD-V-7230-V-MPS</b>	72	30	29	195	42	<b>2260</b>
	Table de travail rectangulaire avec piètement O5 en bois.  <i>Table desk with wooden O5 legs, rectangular top.</i>	<b>O5-TD-V-8436-V</b>	84	36	29	250	60	<b>2400</b>
		<b>O5-TD-V-7836-V</b>	78	36	29	225	55	<b>2270</b>
		<b>O5-TD-V-7236-V</b>	72	36	29	205	51	<b>2100</b>
		<b>O5-TD-V-7230-V</b>	72	30	29	195	42	<b>1960</b>
	Bureau directeur double caisson.  <i>Double pedestal executive desk.</i>	<b>O5-AL-7236-BL</b>	72	36	29	380	51	<b>3520</b>
	Bureau directeur avec caisson tout usage à gauche. Pour caisson à droite (O5-7236-AL).  <i>Executive desk with utility pedestal on left. For pedestal on right (O5-7236-AL).</i>	<b>O5-AL-7236</b>	72	36	29	320	51	<b>2480</b>
	Bureau directeur avec caisson filière à gauche. Pour caisson à droite (O5-7236-BL).  <i>Executive desk with filing pedestal on left. For pedestal on right (O5-7236-BL).</i>	<b>O5-BL-7236</b>	72	36	29	320	51	<b>2480</b>
	Cadre de bureau, dos plein.  <i>Desk shell, full back.</i>	<b>O5-7236</b>	72	36	29	220	51	<b>1585</b>
	Table de travail rectangulaire à hauteur ajustable.  <i>Height adjustable table desk with rectangular top.</i>	<b>O5-TD-ADJ-7236</b>	72	36	25-50 min.-max.	350	51	<b>2875</b>

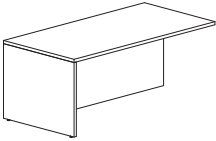
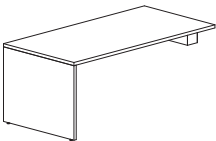
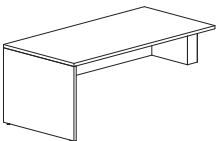

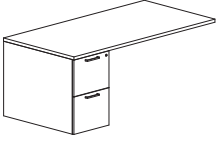
MODÈLE MODEL	DESCRIPTION	CODE	LARG. WIDTH "	PROF. DEPTH "	HAUT HEIGHT "	POIDS WEIGHT LBS LBS	VOLUME VOLUME PI <sup>3</sup> FT <sup>3</sup>	BOIS WOOD \$
	Table de travail avec caisson tout usage à gauche, demi-modestie et pattes O5 en bois. Pour caisson à droite (O5-TD-V-7236-AL-MPS).  <i>Table desk with utility pedestal on left, short modesty and wooden O5 legs. For pedestal on right (O5-TD-V-7236-AL-MPS).</i>	<b>O5-AL-7236-V-MPS</b>	72	36	29	320	51	<b>3150</b>
	Table de travail avec caisson filière à gauche, demi-modestie et pattes O5 en bois. Pour caisson à droite (O5-TD-V-7236-BL-MPS).  <i>Table desk with filing pedestal on left, short modesty and wooden O5 legs. For pedestal on right (O5-TD-V-7236-BL-MPS).</i>	<b>O5-BL-7236-V-MPS</b>	72	36	29	320	51	<b>3150</b>
	Table de travail avec caisson bas à gauche, demi-modestie et pattes O5 en bois. Pour caisson à droite (O5-TD-V-7236-CL-MPS).  <i>Table desk with low pedestal on left, short modesty and wooden O5 legs. For pedestal on right (O5-TD-V-7236-CL-MPS).</i>	<b>O5-CL-7236-V-MPS</b>	72	36	29	320	51	<b>2810</b>
	Table retour avec pattes O5 en bois à gauche. Pour pattes à droite (O5-TD-7236-V).  <i>Table return with wooden O5 legs on left. For legs on right (O5-TD-7236-V).</i>	<b>O5-TD-V-7236</b> <b>O5-TD-V-7230</b> <b>O5-TD-V-6636</b> <b>O5-TD-V-6630</b>	72 72 66 66	36 30 36 30	29 29 29 29	165 160 145 130	51 42 45 38	<b>1595</b> <b>1460</b> <b>1460</b> <b>1370</b>
	Table retour avec pattes O5 en bois à gauche, espaceur 7" à droite. Pour pattes à droite (O5-TD-RZ1-7236-V).  <i>Table return with wooden O5 legs on left and 7" riser on right. For legs on right (O5-TD-RZ1-7236-V).</i>	<b>O5-TD-V-7236-RZ1</b> <b>O5-TD-V-7230-RZ1</b> <b>O5-TD-V-6636-RZ1</b> <b>O5-TD-V-6630-RZ1</b>	72 72 66 66	36 30 36 30	29 29 29 29	175 170 155 140	51 42 45 38	<b>1750</b> <b>1600</b> <b>1600</b> <b>1510</b>
	Table retour avec pattes O5 en bois à gauche, espaceur 13" à droite. Pour pattes à droite (O5-TD-RZ2-7236-V).  <i>Table return with wooden O5 legs on left and 13" riser on right. For legs on right (O5-TD-RZ2-7236-V).</i>	<b>O5-TD-V-7236-RZ2</b> <b>O5-TD-V-7230-RZ2</b> <b>O5-TD-V-6636-RZ2</b> <b>O5-TD-V-6630-RZ2</b>	72 72 66 66	36 30 36 30	29 29 29 29	180 175 160 145	51 42 45 38	<b>1760</b> <b>1610</b> <b>1610</b> <b>1520</b>

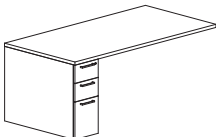
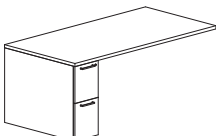
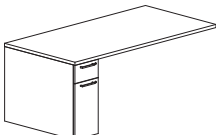
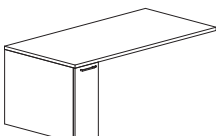

MODÈLE MODEL	DESCRIPTION	CODE	LARG. WIDTH "	PROF. DEPTH "	HAUT HEIGHT "	POIDS WEIGHT LBS LBS	VOLUME VOLUME PI <sup>3</sup> FT <sup>3</sup>	BOIS WOOD \$
	Retour directeur gauche. Pour retour droit (O5- <b>ERR</b> -7236).  <i>Left executive return. For right return (O5-<b>ERR</b>-7236).</i>	<b>O5-ERL-7236</b>	72	36	29	200	51	<b>1275</b>
	Retour directeur gauche avec espaceur de 7". Pour retour droit (O5- <b>ERR</b> -RZ1-7236).  <i>Left executive return with 7" riser. For right return (O5-<b>ERR</b>-RZ1-7236).</i>	<b>O5-ERL-7236-RZ1</b>	72	36	29	200	51	<b>1280</b>
	Retour directeur gauche avec espaceur de 13" et demi-modestie. Pour retour droit (O5- <b>ERR</b> -RZ2-7236-MPS).  <i>Left executive return with 7" riser and short modesty panel. For right return (O5-<b>ERR</b>-RZ2-7236-MPS).</i>	<b>O5-ERL-7236-RZ2-MPS</b>	72	36	29	205	51	<b>1350</b>
	Retour directeur gauche avec caisson tout usage. Pour retour droit (O5- <b>ERR</b> -7236- <b>AL</b> ).  <i>Left executive return with utility pedestal. For right return (O5-<b>ERR</b>-7236-<b>AL</b>).</i>	<b>O5-ERL-AL-7236</b>	72	36	29	300	51	<b>2200</b>
	Retour directeur gauche avec caisson filière. Pour retour droit (O5- <b>ERR</b> -7236- <b>BL</b> ).  <i>Left executive return with filing pedestal. For right return (O5-<b>ERR</b>-7236-<b>BL</b>).</i>	<b>O5-ERL-BL-7236</b>	72	36	29	300	51	<b>2200</b>

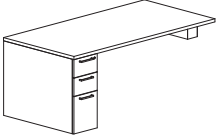
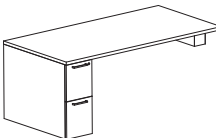
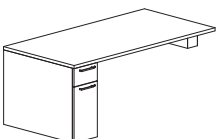
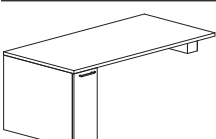
MODÈLE MODEL	DESCRIPTION	CODE	LARG. WIDTH "	PROF. DEPTH "	HAUT HEIGHT "	POIDS WEIGHT LBS LBS	VOLUME VOLUME PI <sup>3</sup> FT <sup>3</sup>	BOIS WOOD \$
	Retour directeur gauche avec espaceur de 7" et caisson tout usage. Pour retour droit (O5- <b>ERR-RZ1-7236-AL</b> ).  <i>Left executive return with 7" riser and utility pedestal. For right return (O5-<b>ERR-RZ1-7236-AL</b>).</i>	<b>O5-ERL-AL-7236-RZ1</b>	72	36	29	305	51	<b>2350</b>
	Retour directeur gauche avec espaceur de 7" et caisson filière. Pour retour droit (O5- <b>ERR-RZ1-7236-BL</b> ).  <i>Left executive return with 7" riser and filing pedestal. For right return (O5-<b>ERR-RZ1-7236-BL</b>).</i>	<b>O5-ERL-BL-7236-RZ1</b>	72	36	29	305	51	<b>2350</b>
	Retour directeur gauche avec caisson tout usage de 12". Pour retour droit (O5- <b>ERR-7236-A12</b> ).  <i>Left executive return with 12" utility pedestal. For right return (O5-<b>ERR-7236-A12</b>).</i>	<b>O5-ERL-A12-7236</b>	72	36	29	290	51	<b>2200</b>
	Retour directeur gauche avec caisson filière de 12". Pour retour droit (O5- <b>ERR-7236-B12</b> ).  <i>Left executive return with 12" filing pedestal. For right return (O5-<b>ERR-7236-B12</b>).</i>	<b>O5-ERL-B12-7236</b>	72	36	29	290	51	<b>2200</b>
	Retour directeur gauche avec caisson utilité/CPU de 12". Pour retour droit (O5- <b>ERR-7236-AH12</b> ).  <i>Left executive return with 12" utility/CPU pedestal. For right return (O5-<b>ERR-7236-AH12</b>).</i>	<b>O5-ERL-AH12-7236</b>	72	36	29	290	51	<b>2160</b>
	Retour directeur gauche avec caisson CPU de 12". Pour retour droit (O5- <b>ERR-7236-H12</b> ).  <i>Left executive return with 12" CPU pedestal. For right return (O5-<b>ERR-7236-H12</b>).</i>	<b>O5-ERL-H12-7236</b>	72	36	29	290	51	<b>2160</b>

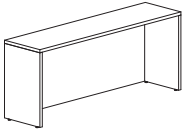
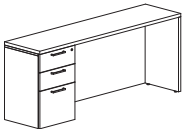
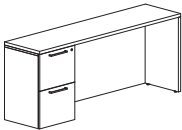
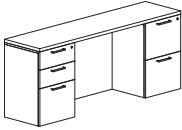
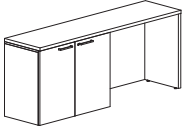
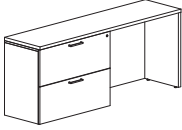
MODÈLE MODEL	DESCRIPTION	CODE	LARG. WIDTH "	PROF. DEPTH "	HAUT HEIGHT "	POIDS WEIGHT LBS LBS	VOLUME VOLUME PI <sup>3</sup> FT <sup>3</sup>	BOIS WOOD \$
	Retour directeur gauche avec espaceur de 7" et caisson tout usage 12". Pour retour droit (O5- <b>ERR</b> -RZ1-7236- <b>A12</b> ).  <i>Left executive return with 7" riser and 12" utility pedestal. For right return (O5-<b>ERR</b>-RZ1-7236-<b>A12</b>).</i>	<b>O5-ERL-A12-7236-RZ1</b>	72	36	29	295	51	<b>2300</b>
	Retour directeur gauche avec espaceur de 7" et caisson filière 12". Pour retour droit (O5- <b>ERR</b> -RZ1-7236- <b>B12</b> ).  <i>Left executive return with 7" riser and 12" filing pedestal. For right return (O5-<b>ERR</b>-RZ1-7236-<b>B12</b>).</i>	<b>O5-ERL-B12-7236-RZ1</b>	72	36	29	295	51	<b>2300</b>
	Retour directeur gauche avec espaceur de 7" et caisson tout usage/CPU 12". Pour retour droit (O5- <b>ERR</b> -RZ1-7236- <b>AH12</b> ).  <i>Left executive return with 7" riser and 12" utility/CPU pedestal. For right return (O5-<b>ERR</b>-RZ1-7236-<b>AH12</b>).</i>	<b>O5-ERL-AH12-7236-RZ1</b>	72	36	29	295	51	<b>2250</b>
	Retour directeur gauche avec espaceur de 7" et caisson CPU 12". Pour retour droit (O5- <b>ERR</b> -RZ1-7236- <b>H12</b> ).  <i>Left executive return with 7" riser and 12" CPU pedestal. For right return (O5-<b>ERR</b>-RZ1-7236-<b>H12</b>).</i>	<b>O5-ERL-H12-7236-RZ1</b>	72	36	29	295	51	<b>2180</b>

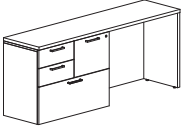
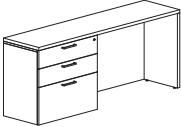
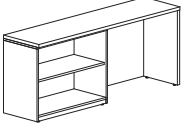
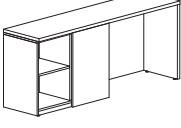

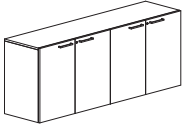
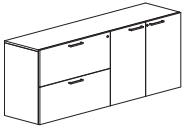

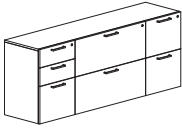
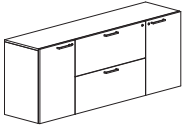
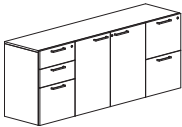
MODÈLE MODEL	DESCRIPTION	CODE	LARG. WIDTH "	PROF. DEPTH "	HAUT HEIGHT "	POIDS WEIGHT LBS LBS	VOLUME VOLUME PI <sup>3</sup> FT <sup>3</sup>	BOIS WOOD \$
	Bahut ouvert. <i>Credenza shell.</i>	<b>O5-7218</b>	72	18	29	175	30	<b>1190</b>
	Bahut avec 1 caisson tout usage à gauche. Pour caisson à droite (O5-7218- <b>AL</b> ).  <i>Credenza with 1 utility pedestal on left. For right pedestal (O5-7218-<b>AL</b>).</i>	<b>O5-AL-7218</b>	72	18	29	215	30	<b>2420</b>
	Bahut avec 1 caisson filière à gauche. Pour caisson à droite (O5-7218- <b>BL</b> ).  <i>Credenza with 1 filing pedestal on left. For right pedestal (O5-7218-<b>BL</b>).</i>	<b>O5-BL-7218</b>	72	18	29	215	30	<b>2420</b>
	Bahut double caisson.  <i>Kneespace credenza with 2 pedestals</i>	<b>O5-AL-7218-BL</b>	72	18	29	255	30	<b>3370</b>
	Bahut avec 1 armoire à gauche. Pour armoire à droite (O5-7218- <b>HL</b> ).  <i>Credenza with 1 storage cabinet on left. For right cabinet (O5-7218-<b>HL</b>).</i>	<b>O5-HL-7218</b>	72	18	29	220	30	<b>2370</b>
	Bahut avec 1 classeur latéral à gauche. Pour filière à droite (O5-7218- <b>FL</b> ).  <i>Credenza with 1 lateral file on left. For right file (O5-7218-<b>FL</b>).</i>	<b>O5-FL-7218</b>	72	18	29	240	30	<b>2830</b>

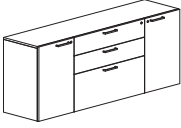
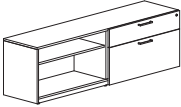
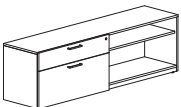
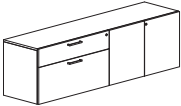

MODÈLE MODEL	DESCRIPTION	CODE	LARG. WIDTH "	PROF. DEPTH "	HAUT HEIGHT "	POIDS WEIGHT LBS LBS	VOLUME VOLUME PI <sup>3</sup> FT <sup>3</sup>	BOIS WOOD \$
	Bahut avec 1 classeur modulaire à gauche. Pour classeur à droite (O5-7218- <b>FBL</b> ).  <i>Credenza with 1 modular file on left. For right modular file (O5-7218-<b>FBL</b>).</i>	<b>O5-FBL-7218</b>	72	18	29	240	30	<b>3100</b>
	Bahut avec classeur utilité à gauche. Pour classeur à droite (O5-7218- <b>A36</b> ).  <i>Credenza with utility file on left. For right utility file (O5-7218-<b>A36</b>).</i>	<b>O5-A36-7218</b>	72	18	29	240	30	<b>3090</b>
	Bahut avec 1 armoire ouverte à gauche. Pour armoire à droite (O5-7218- <b>OL</b> ).  <i>Credenza with 1 open storage cabinet on left. For right cabinet (O5-7218-<b>OL</b>).</i>	<b>O5-OL-7218</b>	72	18	29	210	30	<b>1900</b>
	Bahut avec 1 armoire porte coulissante à gauche. Pour armoire à droite (O5-7218- <b>PC36</b> ).  <i>Credenza with 1 storage cabinet with sliding door on left. For right cabinet (O5-7218-<b>PC36</b>).</i>	<b>O5-PC36-7218</b>	72	18	29	220	30	<b>2510</b>

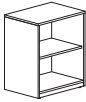
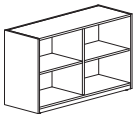

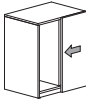
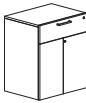



MODÈLE MODEL	DESCRIPTION	CODE	LARG. WIDTH "	PROF. DEPTH "	HAUT HEIGHT "	POIDS WEIGHT LBS LBS	VOLUME VOLUME PI <sup>3</sup> FT <sup>3</sup>	BOIS WOOD \$
	Bahut avec 2 armoires.  <i>Credenza with 2 storage cabinets.</i>	<b>O5-HL-7218-HL</b>	72	18	28	240	30	<b>2970</b>
	Bahut avec 1 classeur latéral et 1 armoire.  <i>Credenza with 1 lateral file and 1 storage cabinet.</i>	<b>O5-FL-7218-HL</b>	72	18	28	275	30	<b>3050</b>
	Bahut avec 2 classeurs latéraux.  <i>Credenza with 2 lateral files.</i>	<b>O5-FL-7218-FL</b>	72	18	28	290	30	<b>3480</b>
	Bahut avec 2 caissons et 1 classeur latéral.  <i>Credenza with 2 pedestals and 1 lateral file.</i>	<b>O5-AL-FL-7218-BL</b>	72	18	28	330	30	<b>4560</b>
	Bahut avec 2 demie-armoires et 1 classeur latéral.  <i>Credenza with 2 half bookcases and 1 lateral file.</i>	<b>O5-HSL-FL-7218-HSR</b>	72	18	28	300	30	<b>4280</b>
	Bahut avec 2 caissons et 1 armoire.  <i>Credenza with 2 pedestals and 1 storage cabinet.</i>	<b>O5-AL-HL-7218-BL</b>	72	18	28	310	30	<b>4110</b>

MODÈLE MODEL	DESCRIPTION	CODE	LARG. WIDTH "	PROF. DEPTH "	HAUT HEIGHT "	POIDS WEIGHT LBS LBS	VOLUME VOLUME PI <sup>3</sup> FT <sup>3</sup>	BOIS WOOD \$
	Bahut avec 2 demie-armoires et 1 classeur utilité.  <i>Credenza with 2 half bookcases and 1 utility file.</i>	<b>O5-HSL-A36-7218-HSR</b>	72	18	28	310	30	<b>4340</b>
	Bahut bas avec 1 armoire ouverte et 1 filière utilité simple.  <i>Low credenza with 1 open bookcase and 1 single utility-file.</i>	<b>O5-OLZ-7218-CLZ</b>	72	18	21	250	27	<b>2890</b>
	Bahut bas avec 1 filière utilité simple et 1 armoire ouverte.  <i>Low credenza with 1 single utility-file and 1 open bookcase.</i>	<b>O5-CLZ-7218-OLZ</b>	72	18	21	250	27	<b>2890</b>
	Bahut bas avec 1 classeur utilité simple et 1 armoire.  <i>Low credenza with 1 single utility-file and 1 storage cabinet.</i>	<b>O5-CLZ-7218-HLZ</b>	72	18	21	260	27	<b>3000</b>



MODÈLE MODEL	DESCRIPTION	CODE	LARG. WIDTH "	PROF. DEPTH "	HAUT HEIGHT "	POIDS WEIGHT LBS LBS	VOLUME VOLUME PI <sup>3</sup> FT <sup>3</sup>	BOIS WOOD \$
	Armoire ouverte avec 1 tablette réglable.	<b>O5-O12-28</b>	12	18	28	40	6	<b>720</b>
		<b>O5-O18-28</b>	18	18	28	60	8	<b>790</b>
		<b>O5-O24-28</b>	24	18	28	90	10	<b>990</b>
	<i>Open bookcase with 1 adjustable shelf.</i>	<b>O5-O-28</b>	30	18	28	110	13	<b>1050</b>
		<b>O5-OL-28</b>	36	18	28	120	15	<b>1110</b>
	Armoire ouverte double avec 2 tablettes réglable et division centrale.	<b>O5-OL-4818-28</b>	48	18	28	130	18	<b>1480</b>
	<i>Double open bookcase with 2 adjustable shelves and center divider.</i>							
	Armoire fermée avec 1 tablette réglable.	<b>O5-H-12-28</b>	12	18	28	70	6	<b>910</b>
		<b>O5-H-18-28</b>	18	18	28	60	8	<b>980</b>
		<b>O5-H-24-28</b>	24	18	28	110	10	<b>1170</b>
	<i>Closed bookcase with 1 adjustable shelf.</i>	<b>O5-H-28</b>	30	18	28	125	13	<b>1240</b>
		<b>O5-HL-28</b>	36	18	28	135	15	<b>1310</b>
	Armoire semi-ouverte avec porte coulissante.	<b>O5-HPC-2418-28</b>	24	18	28	110	10	<b>1330</b>
		<b>O5-HPC-3018-28</b>	30	18	28	125	13	<b>1390</b>
		<b>O5-HPC-3618-28</b>	36	18	28	135	15	<b>1450</b>
	<i>Half closed bookcase with sliding door.</i>							
	Armoire fermée avec tiroir 6" et 1 tablette réglable.	<b>O5-D1218-28</b>	12	18	28	70	6	<b>1110</b>
		<b>O5-D1818-28</b>	18	18	28	90	8	<b>1250</b>
		<b>O5-D2418-28</b>	24	18	28	110	10	<b>1780</b>
		<b>O5-D3018-28</b>	30	18	28	130	13	<b>1880</b>
	<i>Closed bookcase with 6" utility drawer and 1 adjustable shelf.</i>	<b>O5-D3618-28</b>	36	18	28	140	15	<b>1950</b>
	Caisson tout usage.	<b>O5-A-18-28</b>	12	18	28	70	6	<b>1110</b>
		<b>O5-AL-18-28</b>	18	18	28	90	8	<b>1250</b>
	<i>Utility pedestal.</i>	<b>O5-AL24-18-28</b>	24	18	28	110	10	<b>1780</b>
		<b>O5-AL30-18-28</b>	30	18	28	130	13	<b>1880</b>
		<b>O5-AL36-18-28</b>	36	18	28	140	15	<b>1950</b>

MODÈLE MODEL	DESCRIPTION	CODE	LARG. WIDTH "	PROF. DEPTH "	HAUT HEIGHT "	POIDS WEIGHT LBS LBS	VOLUME VOLUME PI <sup>3</sup> FT <sup>3</sup>	BOIS WOOD \$
	Caisson filière.	<b>O5-B-18-29</b>	12	18	29	70	6	<b>1110</b>
		<b>O5-BL-18-29</b>	18	18	29	90	8	<b>1250</b>
	Filing pedestal.	<b>O5-BL24-18-29</b>	24	18	29	110	10	<b>1630</b>
		<b>O5-BL30-18-29</b>	30	18	29	130	13	<b>1730</b>
		<b>O5-BL36-18-29</b>	36	18	29	140	15	<b>1890</b>
	Classeur modulaire.	<b>O5-FB-18-29</b>	30	18	29	130	13	<b>1900</b>
	Modular file.	<b>O5-FBL-18-29</b>	36	18	29	140	15	<b>1960</b>
	Caisson utilité-filière simple.	<b>O5-C-18-21</b>	12	18	21	70	6	<b>1060</b>
		<b>O5-CL-18-21</b>	18	18	21	90	8	<b>1200</b>
	Single Utility-file pedestal.	<b>O5-CL24-18-21</b>	24	18	21	110	10	<b>1580</b>
		<b>O5-CL30-18-21</b>	30	18	21	130	13	<b>1680</b>
		<b>O5-CL36-18-21</b>	36	18	21	140	15	<b>1840</b>
	<b>-R</b> Option roulettes <b>-R</b> Option casters	Ajoutez <b>110 \$</b> Add <b>110 \$</b>						
	Armoire ouverte basse avec 1 tablette ajustable.	<b>O5-O12-18-21</b>	12	18	21	60	5	<b>720</b>
		<b>O5-O18-18-21</b>	18	18	21	80	7	<b>790</b>
		<b>O5-O24-18-21</b>	24	18	21	100	9	<b>990</b>
	Low Open bookcase with 1 adjustable shelf.	<b>O5-O-18-21</b>	30	18	21	110	12	<b>1050</b>
		<b>O5-OL-18-21</b>	36	18	21	120	14	<b>1110</b>
	<b>-R</b> Option roulettes <b>-R</b> Option casters	Ajoutez <b>110 \$</b> Add <b>110 \$</b>						
	Armoire fermée basse avec porte(s) à charnière(s) et 1 tablette réglable.	<b>O5-H12-18-21</b>	12	18	21	70	5	<b>910</b>
		<b>O5-H18-18-21</b>	18	18	21	90	7	<b>980</b>
		<b>O5-H24-18-21</b>	24	18	21	110	9	<b>1170</b>
		<b>O5-H-18-21</b>	30	18	21	120	12	<b>1240</b>
	Low Closed bookcase with hinged door(s) and 1 adjustable shelf.	<b>O5-HL-18-21</b>	36	18	21	30	14	<b>1310</b>
	<b>-R</b> Option roulettes <b>-R</b> Option casters	Ajoutez <b>110 \$</b> Add <b>110 \$</b>						
	Armoire semi-ouverte basse avec porte coulissante et 1 tablette réglable.	<b>O5-HPC24-18-21</b>	24	18	21	110	9	<b>1170</b>
		<b>O5-HPC-18-21</b>	30	18	21	130	12	<b>1240</b>
		<b>O5-HPCL-18-21</b>	36	18	21	140	14	<b>1310</b>
	Low Half-closed bookcase with sliding door and 1 adjustable shelf							
	<b>-R</b> Option roulettes <b>-R</b> Option casters	Ajoutez <b>110 \$</b> Add <b>110 \$</b>						

MODÈLE MODEL	DESCRIPTION	CODE	LARG. WIDTH "	PROF. DEPTH "	HAUT HEIGHT "	POIDS WEIGHT LBS LBS	VOLUME VOLUME PI <sup>3</sup> FT <sup>3</sup>	BOIS WOOD \$
	Classeur latéral	<b>O5-F3T-18</b>	30	18	42	150	20	<b>2250</b>
	3 tiroirs filières	<b>O5-FL3T-18</b>	36	18	42	170	25	<b>2360</b>
		<b>O5-F3T-24</b>	30	24	42	160	21	<b>2480</b>
	<i>Lateral file</i>	<b>O5-FL3T-24</b>	36	24	42	180	26	<b>2600</b>
	<i>3 filing drawers</i>							
	Classeur latéral	<b>O5-F4T-18</b>	30	18	56	200	27	<b>2590</b>
	4 tiroirs filières	<b>O5-FL4T-18</b>	36	18	56	220	32	<b>2700</b>
		<b>O5-F4T-24</b>	30	24	56	210	28	<b>2860</b>
	<i>Lateral file</i>	<b>O5-FL4T-24</b>	36	24	56	230	33	<b>2980</b>
	<i>4 filing drawers</i>							
	Dessus pour modules de rangement.	<b>O5-TOP-__ 15</b>	XX	15				<b>130</b>
	<b>Prix au pied linéaire.</b>	<b>O5-TOP-__ 18</b>	XX	18				<b>140</b>
		<b>O5-TOP-__ 20</b>	XX	20				<b>155</b>
	<i>Top for storage units.</i>	<b>O5-TOP-__ 24</b>	XX	24				<b>165</b>
	<b>Price per linear foot.</b>	<b>O5-TOP-__ 30</b>	XX	30				<b>185</b>
		<b>O5-TOP-__ 36</b>	XX	36				<b>220</b>
Pour dessus arrondi ( <b>TOPW</b> ), ajoutez \$ 100 par pied linéaire. For bow top ( <b>TOPW</b> ), add \$ 100 per linear foot.								
	Panneau de modestie.	<b>O5-MP-30</b>	30		27			<b>310</b>
		<b>O5-MP-36</b>	36		27			<b>360</b>
	<i>Modesty panel.</i>	<b>O5-MP-48</b>	48		27			<b>420</b>
		<b>O5-MP-60</b>	60		27			<b>530</b>
		<b>O5-MP-72</b>	72		27			<b>660</b>
	Panneau de modestie court.	<b>O5-MPS-30</b>	30		6			<b>260</b>
		<b>O5-MPS-36</b>	36		6			<b>310</b>
	<i>Short modesty panel.</i>	<b>O5-MPS-48</b>	48		6			<b>370</b>
		<b>O5-MPS-60</b>	60		6			<b>480</b>
		<b>O5-MPS-72</b>	72		6			<b>610</b>
	Piètement pour composer un bahut.	<b>O5-EP-18</b>	18		29			<b>310</b>
	<i>Leg to built a credenza.</i>	<b>O5-EP-24</b>	24		29			<b>350</b>

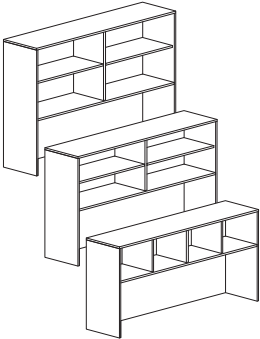
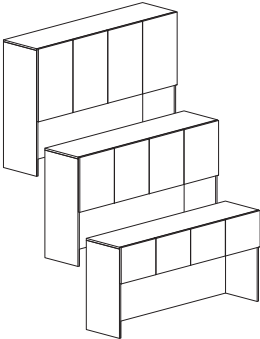
MODÈLE MODEL	DESCRIPTION	CODE	LARG. WIDTH "	PROF. DEPTH "	HAUT HEIGHT "	POIDS WEIGHT LBS LBS	VOLUME VOLUME PI <sup>3</sup> FT <sup>3</sup>	PORTES DOORS	BOIS WOOD
	Huche ouverte.	<b>O5-OCO-3536-15</b>	36	15	35	80	15		<b>1100</b>
		<b>O5-OCO-3548-15</b>	48	15	35	100	21		<b>1350</b>
	Open overhead cabinet.	<b>O5-OCO-3560-15</b>	60	15	35	125	26		<b>1590</b>
		<b>O5-OCO-3572-15</b>	72	15	35	150	32		<b>1790</b>
		<b>O5-OCO-3584-15</b>	84	15	35	180	37		<b>2240</b>
		<b>O5-OCO-3536-18</b>	36	18	35	80	16		<b>1160</b>
		<b>O5-OCO-3548-18</b>	48	18	35	100	22		<b>1420</b>
		<b>O5-OCO-3560-18</b>	60	18	35	125	27		<b>1670</b>
		<b>O5-OCO-3572-18</b>	72	18	35	150	33		<b>1880</b>
		<b>O5-OCO-3584-18</b>	84	18	35	180	39		<b>2350</b>
		<b>O5-OCO-4236-15</b>	36	15	42	85	17		<b>1210</b>
		<b>O5-OCO-4248-15</b>	48	15	42	130	23		<b>1490</b>
		<b>O5-OCO-4260-15</b>	60	15	42	135	28		<b>1760</b>
		<b>O5-OCO-4272-15</b>	72	15	42	160	34		<b>1980</b>
		<b>O5-OCO-4284-15</b>	84	15	42	190	39		<b>2480</b>
		<b>O5-OCO-4236-18</b>	36	18	42	85	18		<b>1270</b>
		<b>O5-OCO-4248-18</b>	48	18	42	130	24		<b>1560</b>
		<b>O5-OCO-4260-18</b>	60	18	42	135	30		<b>1850</b>
		<b>O5-OCO-4272-18</b>	72	18	42	160	35		<b>2080</b>
		<b>O5-OCO-4284-18</b>	84	18	42	190	40		<b>2600</b>
	<b>O5-OCO-4936-15</b>	36	15	49	90	21		<b>1310</b>	
	<b>O5-OCO-4948-15</b>	48	15	49	110	27		<b>1570</b>	
	<b>O5-OCO-4960-15</b>	60	15	49	140	33		<b>1830</b>	
	<b>O5-OCO-4972-15</b>	72	15	49	155	40		<b>2090</b>	
	<b>O5-OCO-4984-15</b>	84	15	49	180	46		<b>2490</b>	
	<b>O5-OCO-4936-18</b>	36	18	49	85	23		<b>1375</b>	
	<b>O5-OCO-4948-18</b>	48	18	49	110	29		<b>1650</b>	
	<b>O5-OCO-4960-18</b>	60	18	49	140	35		<b>1920</b>	
	<b>O5-OCO-4972-18</b>	72	18	49	155	42		<b>2190</b>	
	<b>O5-OCO-4984-18</b>	84	18	49	180	48		<b>2610</b>	
	Huche avec portes à charnières.	<b>O5-OCH-3536-15</b>	36	15	35	95	15	2	<b>1300</b>
		<b>O5-OCH-3548-15</b>	48	15	35	120	21	3	<b>1540</b>
	Overhead cabinet with hinged doors.	<b>O5-OCH-3560-15</b>	60	15	35	145	26	4	<b>1790</b>
		<b>O5-OCH-3572-15</b>	72	15	35	170	32	4	<b>1980</b>
		<b>O5-OCH-3584-15</b>	84	15	35	200	37	6	<b>2430</b>
		<b>O5-OCH-3536-18</b>	36	18	35	95	16	2	<b>1370</b>
		<b>O5-OCH-3548-18</b>	48	18	35	120	22	3	<b>1620</b>
		<b>O5-OCH-3560-18</b>	60	18	35	145	27	4	<b>1880</b>
		<b>O5-OCH-3572-18</b>	72	18	35	170	33	4	<b>2080</b>
		<b>O5-OCH-3584-18</b>	84	18	35	200	38	6	<b>2550</b>
		<b>O5-OCH-4236-15</b>	36	15	42	100	17	2	<b>1430</b>
		<b>O5-OCH-4248-15</b>	48	15	42	125	23	3	<b>1710</b>
		<b>O5-OCH-4260-15</b>	60	15	42	150	28	4	<b>1980</b>
		<b>O5-OCH-4272-15</b>	72	15	42	175	34	4	<b>2200</b>
		<b>O5-OCH-4284-15</b>	84	15	42	205	39	6	<b>2700</b>
		<b>O5-OCH-4236-18</b>	36	18	42	100	18	2	<b>1500</b>
		<b>O5-OCH-4248-18</b>	48	18	42	125	24	3	<b>1800</b>
		<b>O5-OCH-4260-18</b>	60	18	42	150	30	4	<b>2080</b>
		<b>O5-OCH-4272-18</b>	72	18	42	175	35	4	<b>2310</b>
		<b>O5-OCH-4284-18</b>	84	18	42	205	40	6	<b>2840</b>
	<b>O5-OCH-4936-15</b>	36	15	49	100	21	2	<b>1510</b>	
	<b>O5-OCH-4948-15</b>	48	15	49	125	27	3	<b>1860</b>	
	<b>O5-OCH-4960-15</b>	60	15	49	150	33	4	<b>2220</b>	
	<b>O5-OCH-4972-15</b>	72	15	49	175	40	4	<b>2490</b>	
	<b>O5-OCH-4984-15</b>	84	15	49	205	46	6	<b>2970</b>	
	<b>O5-OCH-4936-18</b>	36	18	49	100	23	2	<b>1590</b>	
	<b>O5-OCH-4948-18</b>	48	18	49	125	29	3	<b>1950</b>	
	<b>O5-OCH-4960-18</b>	60	18	49	150	35	4	<b>2330</b>	
	<b>O5-OCH-4972-18</b>	72	18	49	175	42	4	<b>2610</b>	
	<b>O5-OCH-4984-18</b>	84	18	49	205	48	6	<b>3120</b>	

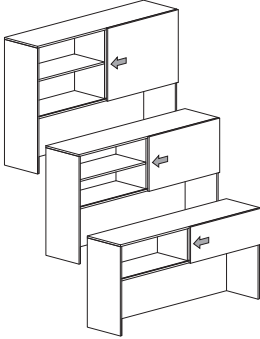
MODÈLE MODEL	DESCRIPTION	CODE	LARG. WIDTH "	PROF. DEPTH "	HAUT HEIGHT "	POIDS WEIGHT LBS LBS	VOLUME VOLUME PI <sup>3</sup> FT <sup>3</sup>	BOIS WOOD \$
	Huche semi-ouverte avec porte colissante.	<b>O5-OCPC-3536-15</b>	36	15	35	95	15	<b>1350</b>
		<b>O5-OCPC-3548-15</b>	48	15	35	120	21	<b>1600</b>
		<b>O5-OCPC-3560-15</b>	60	15	35	145	26	<b>1840</b>
	Semi-closed hutch with sliding door.	<b>O5-OCPC-3572-15</b>	72	15	35	170	32	<b>2040</b>
		<b>O5-OCPC-3584-15</b>	84	15	35	200	37	<b>2490</b>
		<b>O5-OCPC-3536-18</b>	36	18	35	95	16	<b>1410</b>
		<b>O5-OCPC-3548-18</b>	48	18	35	120	22	<b>1670</b>
		<b>O5-OCPC-3560-18</b>	60	18	35	145	27	<b>1920</b>
		<b>O5-OCPC-3572-18</b>	72	18	35	170	33	<b>2130</b>
		<b>O5-OCPC-3584-18</b>	84	18	35	200	38	<b>2600</b>
		<b>O5-OCPC-4236-15</b>	36	15	42	100	17	<b>1460</b>
		<b>O5-OCPC-4248-15</b>	48	15	42	125	23	<b>1740</b>
		<b>O5-OCPC-4260-15</b>	60	15	42	150	28	<b>2010</b>
		<b>O5-OCPC-4272-15</b>	72	15	42	175	34	<b>2230</b>
		<b>O5-OCPC-4284-15</b>	84	15	42	205	39	<b>2730</b>
		<b>O5-OCPC-4236-18</b>	36	18	42	100	18	<b>1520</b>
		<b>O5-OCPC-4248-18</b>	48	18	42	125	24	<b>1810</b>
		<b>O5-OCPC-4260-18</b>	60	18	42	150	30	<b>2100</b>
		<b>O5-OCPC-4272-18</b>	72	18	42	175	35	<b>2330</b>
		<b>O5-OCPC-4284-18</b>	84	18	42	205	40	<b>2850</b>
	<b>O5-OCPC-4936-15</b>	36	15	49	100	21	<b>1560</b>	
	<b>O5-OCPC-4948-15</b>	48	15	49	125	27	<b>1820</b>	
	<b>O5-OCPC-4960-15</b>	60	15	49	150	33	<b>2080</b>	
	<b>O5-OCPC-4972-15</b>	72	15	49	175	40	<b>2340</b>	
	<b>O5-OCPC-4984-15</b>	84	15	49	205	46	<b>2740</b>	
	<b>O5-OCPC-4936-18</b>	36	18	49	100	23	<b>1630</b>	
	<b>O5-OCPC-4948-18</b>	48	18	49	125	29	<b>1900</b>	
	<b>O5-OCPC-4960-18</b>	60	18	49	150	35	<b>2170</b>	
	<b>O5-OCPC-4972-18</b>	72	18	49	175	42	<b>2440</b>	
	<b>O5-OCPC-4984-18</b>	84	18	49	205	48	<b>2860</b>	

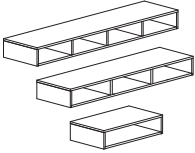
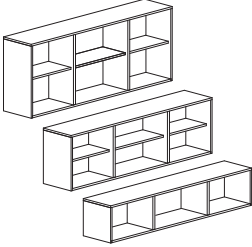

MODÈLE MODEL	DESCRIPTION	CODE	LARG. WIDTH "	PROF. DEPTH "	HAUT HEIGHT "	POIDS WEIGHT LBS LBS	VOLUME VOLUME PI <sup>3</sup> FT <sup>3</sup>	BOIS WOOD \$		
	Huche intermédiaire ouverte. <i>Intermediate open hutch.</i>	<b>O5-WCI-0730-15</b>	30	15	7	15	3	<b>400</b>		
		<b>O5-WCI-0772-15</b>	72	15	7	20	6	<b>680</b>		
		<b>O5-WCI-0784-15</b>	84	15	7	25	7	<b>750</b>		
			<b>O5-WCI-0730-18</b>	30	18	7	15	4	<b>400</b>	
			<b>O5-WCI-0772-18</b>	72	18	7	20	7	<b>680</b>	
			<b>O5-WCI-0784-18</b>	84	18	7	25	8	<b>750</b>	
	Huche ouverte murale et superposable.  <i>Open hutch, wallmounted or stackable.</i>	<b>O5-WCO-1436-15</b>	36	15	14	30	8	<b>870</b>		
		<b>O5-WCO-1448-15</b>	48	15	14	40	11	<b>980</b>		
		<b>O5-WCO-1460-15</b>	60	15	14	50	13	<b>1100</b>		
		<b>O5-WCO-1472-15</b>	72	15	14	60	16	<b>1200</b>		
		<b>O5-WCO-1484-15</b>	84	15	14	110	18	<b>1420</b>		
				<b>O5-WCO-1436-18</b>	36	18	14	30	9	<b>910</b>
				<b>O5-WCO-1448-18</b>	48	18	14	40	12	<b>1030</b>
				<b>O5-WCO-1460-18</b>	60	18	14	50	14	<b>1160</b>
				<b>O5-WCO-1472-18</b>	72	18	14	60	17	<b>1260</b>
				<b>O5-WCO-1484-18</b>	84	18	14	110	19	<b>1490</b>
				<b>O5-WCO-2136-15</b>	36	15	21	35	11	<b>890</b>
				<b>O5-WCO-2148-15</b>	48	15	21	45	14	<b>1015</b>
	<b>O5-WCO-2160-15</b>			60	15	21	55	16	<b>1140</b>	
	<b>O5-WCO-2172-15</b>			72	15	21	65	19	<b>1260</b>	
	<b>O5-WCO-2184-15</b>			84	15	21	115	21	<b>1500</b>	
			<b>O5-WCO-2136-18</b>	36	18	21	35	12	<b>930</b>	
			<b>O5-WCO-2148-18</b>	48	18	21	45	15	<b>1060</b>	
			<b>O5-WCO-2160-18</b>	60	18	21	55	17	<b>1190</b>	
			<b>O5-WCO-2172-18</b>	72	18	21	65	20	<b>1320</b>	
			<b>O5-WCO-2184-18</b>	84	18	21	115	22	<b>1580</b>	
			<b>O5-WCO-2836-15</b>	36	15	28	40	11	<b>910</b>	
			<b>O5-WCO-2848-15</b>	48	15	28	50	15	<b>1050</b>	
			<b>O5-WCO-2860-15</b>	60	15	28	60	18	<b>1180</b>	
			<b>O5-WCO-2872-15</b>	72	15	28	70	22	<b>1310</b>	
<b>O5-WCO-2884-15</b>			84	15	28	115	25	<b>1570</b>		
		<b>O5-WCO-2836-18</b>	36	18	28	40	12	<b>960</b>		
		<b>O5-WCO-2848-18</b>	48	18	28	50	16	<b>1100</b>		
		<b>O5-WCO-2860-18</b>	60	18	28	60	19	<b>1240</b>		
		<b>O5-WCO-2872-18</b>	72	18	28	70	23	<b>1380</b>		
		<b>O5-WCO-2884-18</b>	84	18	28	115	26	<b>1650</b>		

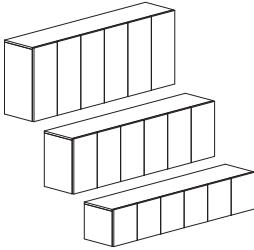
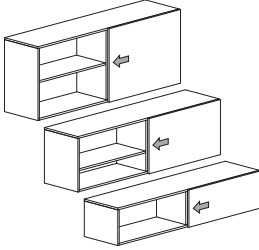
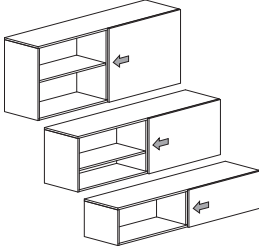
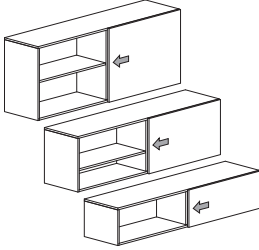
Les huches de 18" sont superposables seulement et ne doivent pas être fixées au mur.  
*18" hutches are stackable only and should not be wallmounted.*

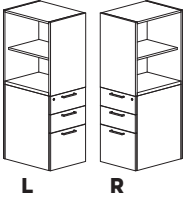
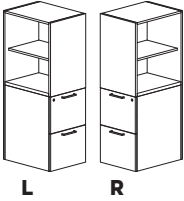
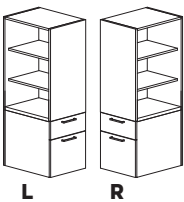
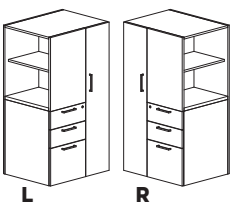
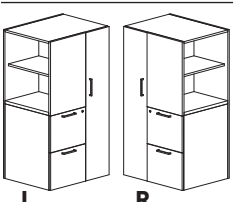
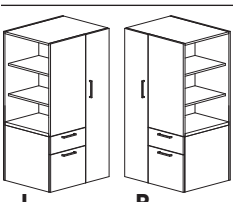
MODÈLE MODEL	DESCRIPTION	CODE	LARG. WIDTH "	PROF. DEPTH "	HAUT HEIGHT "	POIDS WEIGHT LBS LBS	VOLUME VOLUME PI <sup>3</sup> FT <sup>3</sup>	PORTES DOORS \$	BOIS WOOD
	Huche fermée murale ou superposable.	<b>O5-WCH-1436-15</b>	36	15	14	50	8	2	<b>1100</b>
		<b>O5-WCH-1448-15</b>	48	15	14	60	11	3	<b>1270</b>
		<b>O5-WCH-1460-15</b>	60	15	14	70	13	4	<b>1430</b>
		<b>O5-WCH-1472-15</b>	72	15	14	80	16	4	<b>1540</b>
		<b>O5-WCH-1484-15</b>	84	15	14	130	18	6	<b>1820</b>
	<i>Wallmounted or stackable closed hutch with hinged doors.</i>	<b>O5-WCH-1436-18</b>	36	18	14	50	9	2	<b>1150</b>
		<b>O5-WCH-1448-18</b>	48	18	14	60	12	3	<b>1330</b>
		<b>O5-WCH-1460-18</b>	60	18	14	70	14	4	<b>1500</b>
		<b>O5-WCH-1472-18</b>	72	18	14	80	17	4	<b>1620</b>
		<b>O5-WCH-1484-18</b>	84	18	14	130	19	6	<b>1910</b>
	Huche semi-ouverte murale ou superposable avec porte coulissante.	<b>O5-WCPC-1436-15</b>	36	15	14	40	8		<b>1120</b>
		<b>O5-WCPC-1448-15</b>	48	15	14	50	11		<b>1230</b>
		<b>O5-WCPC-1460-15</b>	60	15	14	60	13		<b>1350</b>
		<b>O5-WCPC-1472-15</b>	72	15	14	70	16		<b>1450</b>
		<b>O5-WCPC-1484-15</b>	84	15	14	120	18		<b>1670</b>
	<i>Wallmounted or stackable semi-closed hutch with sliding door.</i>	<b>O5-WCPC-1436-18</b>	36	18	14	40	9		<b>1160</b>
		<b>O5-WCPC-1448-18</b>	48	18	14	50	12		<b>1280</b>
		<b>O5-WCPC-1460-18</b>	60	18	14	60	14		<b>1410</b>
		<b>O5-WCPC-1472-18</b>	72	18	14	70	17		<b>1510</b>
		<b>O5-WCPC-1484-18</b>	84	18	14	120	19		<b>1740</b>
		<b>O5-WCPC-2136-15</b>	36	15	21	45	11		<b>1140</b>
		<b>O5-WCPC-2148-15</b>	48	15	21	55	14		<b>1270</b>
		<b>O5-WCPC-2160-15</b>	60	15	21	65	16		<b>1390</b>
		<b>O5-WCPC-2172-15</b>	72	15	21	75	19		<b>1510</b>
		<b>O5-WCPC-2184-15</b>	84	15	21	125	21		<b>1750</b>
		<b>O5-WCPC-2136-18</b>	36	18	21	45	12		<b>1180</b>
		<b>O5-WCPC-2148-18</b>	48	18	21	55	15		<b>1310</b>
		<b>O5-WCPC-2160-18</b>	60	18	21	65	17		<b>1440</b>
		<b>O5-WCPC-2172-18</b>	72	18	21	75	20		<b>1570</b>
		<b>O5-WCPC-2184-18</b>	84	18	21	125	22		<b>1830</b>
		<b>O5-WCPC-2836-15</b>	36	15	28	50	11		<b>1160</b>
		<b>O5-WCPC-2848-15</b>	48	15	28	60	15		<b>1300</b>
		<b>O5-WCPC-2860-15</b>	60	15	28	70	18		<b>1430</b>
		<b>O5-WCPC-2872-15</b>	72	15	28	80	22		<b>1560</b>
		<b>O5-WCPC-2884-15</b>	84	15	28	130	25		<b>1820</b>
		<b>O5-WCPC-2836-18</b>	36	18	28	50	12		<b>1210</b>
		<b>O5-WCPC-2848-18</b>	48	18	28	60	16		<b>1350</b>
		<b>O5-WCPC-2860-18</b>	60	18	28	70	19		<b>1490</b>
		<b>O5-WCPC-2872-18</b>	72	18	28	80	23		<b>1630</b>
		<b>O5-WCPC-2884-18</b>	84	18	28	130	26		<b>1900</b>

MODÈLE MODEL	DESCRIPTION	CODE	LARG. WIDTH "	PROF. DEPTH "	HAUT. HEIGHT "	POIDS WEIGHT LBS LBS	VOLUME VOLUME PI <sup>3</sup> FT <sup>3</sup>	BOIS WOOD \$
 L R	Tour latérale avec caisson utilité et armoire latérale ouverte.  <i>Lateral tower with utility pedestal and open lateral bookcase.</i>	<b>05-18LA-24</b>	18	24	56	140	22	<b>1850</b>
		<b>05-18LHA-24</b>	18	24	63	155	25	<b>1900</b>
		<b>05-18LA-30</b>	18	30	56	150	24	<b>1940</b>
		<b>05-18LHA-30</b>	18	30	63	165	27	<b>2000</b>
		<b>05-18RA-24</b>	18	24	56	140	22	<b>1850</b>
		<b>05-18RHA-24</b>	18	24	63	155	25	<b>1900</b>
 L R	Tour latérale avec caisson filière et armoire latérale ouverte.  <i>Lateral tower with filing pedestal and open lateral bookcase.</i>	<b>05-18LB-24</b>	18	24	56	140	22	<b>1850</b>
		<b>05-18LHB-24</b>	18	24	63	155	25	<b>1900</b>
		<b>05-18LB-30</b>	18	30	56	150	24	<b>1940</b>
		<b>05-18LHB-30</b>	18	30	63	165	27	<b>2000</b>
		<b>05-18RA-24</b>	18	24	56	140	22	<b>1850</b>
		<b>05-18RHA-24</b>	18	24	63	155	25	<b>1900</b>
 L R	Tour latérale avec caisson utilité et armoire latérale ouverte.  <i>Lateral tower with utility pedestal and open lateral bookcase.</i>	<b>05-18LC-24</b>	18	24	56	140	22	<b>1810</b>
		<b>05-18LHC-24</b>	18	24	63	155	25	<b>1860</b>
		<b>05-18LC-30</b>	18	30	56	150	24	<b>1900</b>
		<b>05-18LHC-30</b>	18	30	63	165	27	<b>1960</b>
		<b>05-18RC-24</b>	18	24	56	140	22	<b>1810</b>
		<b>05-18RHC-24</b>	18	24	63	155	25	<b>1860</b>
 L R	Tour latérale penderie avec caisson utilité et armoire latérale ouverte.  <i>Lateral tower wardrobe with utility pedestal and open lateral bookcase.</i>	<b>05-30LA-24</b>	30	24	56	210	34	<b>3200</b>
		<b>05-30LHA-24</b>	30	24	63	230	40	<b>3250</b>
		<b>05-30LA-30</b>	30	30	56	230	36	<b>3360</b>
		<b>05-30LHA-30</b>	30	30	63	250	42	<b>3430</b>
		<b>05-30RA-24</b>	30	24	56	210	34	<b>3200</b>
		<b>05-30RHA-24</b>	30	24	63	230	40	<b>3250</b>
 L R	Tour latérale penderie avec caisson filière et armoire latérale ouverte.  <i>Lateral tower wardrobe with filing pedestal and open lateral bookcase.</i>	<b>05-30LB-24</b>	30	24	56	210	34	<b>3200</b>
		<b>05-30LHB-24</b>	30	24	63	230	40	<b>3250</b>
		<b>05-30LB-30</b>	30	30	56	230	36	<b>3360</b>
		<b>05-30LHB-30</b>	30	30	63	250	42	<b>3430</b>
		<b>05-30RB-24</b>	30	24	56	210	34	<b>3200</b>
		<b>05-30RHB-24</b>	30	24	63	230	40	<b>3250</b>
 L R	Tour latérale penderie avec caisson utilité et armoire latérale ouverte.  <i>Lateral tower wardrobe with utility pedestal and open lateral bookcase.</i>	<b>05-30LC-24</b>	30	24	56	210	34	<b>3160</b>
		<b>05-30LHC-24</b>	30	24	63	230	40	<b>3210</b>
		<b>05-30LC-30</b>	30	30	56	230	36	<b>3320</b>
		<b>05-30LHC-30</b>	30	30	63	250	42	<b>3400</b>
		<b>05-30RC-24</b>	30	24	56	210	34	<b>3160</b>
		<b>05-30RHC-24</b>	30	24	63	230	40	<b>3210</b>
		<b>05-30RC-30</b>	30	30	56	230	36	<b>3320</b>
		<b>05-30RHC-30</b>	30	30	63	250	42	<b>3400</b>

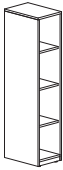

MODÈLE MODEL	DESCRIPTION	CODE	LARG. WIDTH "	PROF. DEPTH "	HAUT HEIGHT "	POIDS WEIGHT LBS LBS	VOLUME VOLUME PI <sup>3</sup> FT <sup>3</sup>	BOIS WOOD \$	
	Demi-armoire penderie gauche. Pour demie-penderie droite (O5-1SR-18)	<b>O5-1SL-18</b>	12	18	63	130	18	<b>1770</b>	
		<b>O5-1SLM-18</b>	12	18	70	135	19	<b>1800</b>	
		<b>O5-1SLH-18</b>	12	18	77	140	19	<b>1830</b>	
	<i>Left half-wardrobe. For half right wardrobe (O5-1SR-18).</i>	<b>O5-1SL-24</b>	12	24	63	140	19	<b>1860</b>	
		<b>O5-1SLM-24</b>	12	24	70	145	20	<b>1890</b>	
		<b>O5-1SLH-24</b>	12	24	77	150	20	<b>1920</b>	
		Demi-armoire ouverte.  <i>Half open bookcase.</i>	<b>O5-7SL-18</b>	12	18	63	130	18	<b>1510</b>
			<b>O5-7SLM-18</b>	12	18	70	135	19	<b>1540</b>
			<b>O5-7SLH-18</b>	12	18	77	140	19	<b>1570</b>
			<b>O5-7SL-24</b>	12	24	63	140	19	<b>1600</b>
			<b>O5-7SLM-24</b>	12	24	70	145	20	<b>1630</b>
			<b>O5-7SLH-24</b>	12	24	77	150	20	<b>1660</b>
		Demi-armoire fermée gauche. Pour demie-armoire droite (O5-8SR-18)	<b>O5-8SL-18</b>	12	18	63	160	18	<b>1900</b>
			<b>O5-8SLM-18</b>	12	18	70	165	19	<b>1930</b>
			<b>O5-8SLH-18</b>	12	18	77	170	19	<b>1960</b>
		<i>Left half closed bookcase. For half right bookcase (O5-8SR-18).</i>	<b>O5-8SL-24</b>	12	24	63	165	19	<b>1990</b>
			<b>O5-8SLM-24</b>	12	24	70	170	20	<b>2020</b>
			<b>O5-8SLH-24</b>	12	24	77	175	20	<b>2050</b>
		Demi-armoire ouverte avec caisson filière.  <i>Open half bookcase with filing pedestal.</i>	<b>O5-12SL-18</b>	12	18	63	135	18	<b>2210</b>
			<b>O5-12SLM-18</b>	12	18	70	140	19	<b>2250</b>
			<b>O5-12SLH-18</b>	12	18	77	145	19	<b>2290</b>
			<b>O5-12SL-24</b>	12	24	63	140	19	<b>2320</b>
			<b>O5-12SLM-24</b>	12	24	70	145	20	<b>2360</b>
			<b>O5-12SLH-24</b>	12	24	77	150	20	<b>2400</b>
		<b>O5-12SL-18-18</b>	18	18	63	140	18	<b>2210</b>	
		<b>O5-12SLM-18-18</b>	18	18	70	145	19	<b>2250</b>	
		<b>O5-12SLH-18-18</b>	18	18	77	150	19	<b>2290</b>	
		<b>O5-12SL-18-24</b>	18	24	63	145	19	<b>2320</b>	
		<b>O5-12SLM-18-24</b>	18	24	70	150	20	<b>2360</b>	
		<b>O5-12SLH-18-24</b>	18	24	77	155	20	<b>2400</b>	

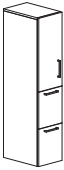
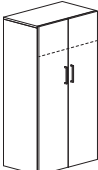
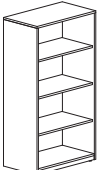
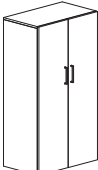
MODÈLE MODEL	DESCRIPTION	CODE	LARG. WIDTH "	PROF. DEPTH "	HAUT HEIGHT "	POIDS WEIGHT LBS LBS	VOLUME VOLUME PI <sup>3</sup> FT <sup>3</sup>	BOIS WOOD \$	
	Demi-armoire fermée de gauche avec caisson filière. Pour armoire de droite (O5-13SR-18).	<b>O5-13SL-18</b>	12	18	63	140	18	<b>2310</b>	
		<b>O5-13SLM-18</b>	12	18	70	145	19	<b>2350</b>	
		<b>O5-13SLH-18</b>	12	18	77	150	19	<b>2390</b>	
	<i>Left closed half bookcase with filing pedestal. For right half bookcase (O5-13SR-18)</i>	<b>O5-13SL-24</b>	12	24	63	145	19	<b>2420</b>	
		<b>O5-13SLM-24</b>	12	24	70	150	20	<b>2460</b>	
		<b>O5-13SLH-24</b>	12	24	77	155	20	<b>2500</b>	
			<b>O5-13SL-18-18</b>	18	18	63	140	18	<b>2310</b>
			<b>O5-13SLM-18-18</b>	18	18	70	145	19	<b>2350</b>
			<b>O5-13SLH-18-18</b>	18	18	77	150	19	<b>2390</b>
			<b>O5-13SL-18-24</b>	18	24	63	145	19	<b>2420</b>
			<b>O5-13SLM-18-24</b>	18	24	70	150	20	<b>2460</b>
			<b>O5-13SLH-18-24</b>	18	24	77	155	20	<b>2500</b>
	Penderie avec 1 tablette fixe et une barre à cintre.	<b>O5-2-18</b>	30	18	63	245	30	<b>1840</b>	
		<b>O5-2M-18</b>	30	18	70	250	33	<b>1940</b>	
		<b>O5-2H-18</b>	30	18	77	255	36	<b>2040</b>	
	<i>Wardrobe with 1 fixed shelf with coat rack.</i>	<b>O5-2-24</b>	30	24	63	250	30	<b>1890</b>	
		<b>O5-2M-24</b>	30	24	70	260	32	<b>1990</b>	
		<b>O5-2H-24</b>	30	24	77	265	34	<b>2090</b>	
			<b>O5-2L-18</b>	36	18	63	250	34	<b>1970</b>
			<b>O5-2LM-18</b>	36	18	70	260	36	<b>2070</b>
			<b>O5-2LH-18</b>	36	18	77	265	38	<b>2170</b>
			<b>O5-2L-24</b>	36	24	63	260	36	<b>2020</b>
			<b>O5-2LM-24</b>	36	24	70	270	38	<b>2120</b>
			<b>O5-2LH-24</b>	36	24	77	275	40	<b>2220</b>
	Armoire ouverte avec tablettes réglables.	<b>O5-7-18</b>	30	18	63	245	30	<b>1400</b>	
		<b>O5-7M-18</b>	30	18	70	250	33	<b>1450</b>	
		<b>O5-7H-18</b>	30	18	77	255	36	<b>1500</b>	
	<i>Open bookcase with adjustable shelves.</i>	<b>O5-7-24</b>	30	24	63	250	30	<b>1590</b>	
		<b>O5-7M-24</b>	30	24	70	260	32	<b>1640</b>	
		<b>O5-7H-24</b>	30	24	77	265	34	<b>1690</b>	
			<b>O5-7L-18</b>	36	18	63	250	34	<b>1550</b>
			<b>O5-7LM-18</b>	36	18	70	260	36	<b>1600</b>
			<b>O5-7LH-18</b>	36	18	77	265	38	<b>1650</b>
			<b>O5-7L-24</b>	36	24	63	260	36	<b>1730</b>
			<b>O5-7LM-24</b>	36	24	70	270	38	<b>1780</b>
			<b>O5-7LH-24</b>	36	24	77	275	40	<b>1830</b>
	Armoire fermée avec tablettes réglables.	<b>O5-8-18</b>	30	18	63	265	30	<b>1960</b>	
		<b>O5-8M-18</b>	30	18	70	270	33	<b>2010</b>	
		<b>O5-8H-18</b>	30	18	77	275	36	<b>2060</b>	
	<i>Closed bookcase with adjustable shelves.</i>	<b>O5-8-24</b>	30	24	63	270	30	<b>2120</b>	
		<b>O5-8M-24</b>	30	24	70	280	32	<b>2170</b>	
		<b>O5-8H-24</b>	30	24	77	285	34	<b>2220</b>	
			<b>O5-8L-18</b>	36	18	63	270	34	<b>2090</b>
			<b>O5-8LM-18</b>	36	18	70	280	36	<b>2140</b>
			<b>O5-8LH-18</b>	36	18	77	285	38	<b>2190</b>
			<b>O5-8L-24</b>	36	24	63	280	36	<b>2250</b>
			<b>O5-8LM-24</b>	36	24	70	290	38	<b>2300</b>
			<b>O5-8LH-24</b>	36	24	77	295	40	<b>2350</b>

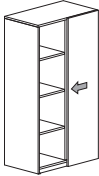
MODÈLE MODEL	DESCRIPTION	CODE	LARG. WIDTH "	PROF. DEPTH "	HAUT HEIGHT "	POIDS WEIGHT LBS LBS	VOLUME VOLUME PI <sup>3</sup> FT <sup>3</sup>	BOIS WOOD \$	
	Armoire semi-ouverte avec porte coulissante.  <i>Half-closed bookcase with sliding door.</i>	<b>O5-8PC-18</b>	30	18	63	265	30	<b>2300</b>	
		<b>O5-8PCM-18</b>	30	18	70	270	33	<b>2350</b>	
		<b>O5-8PCH-18</b>	30	18	77	275	36	<b>2400</b>	
			<b>O5-8PC-24</b>	30	24	63	270	30	<b>2450</b>
			<b>O5-8PCM-24</b>	30	24	70	275	32	<b>2500</b>
			<b>O5-8PCH-24</b>	30	24	77	285	34	<b>2550</b>
			<b>O5-8PCL-18</b>	36	18	63	270	34	<b>2400</b>
			<b>O5-8PCLM-18</b>	36	18	70	280	36	<b>2450</b>
			<b>O5-8PCLH-18</b>	36	18	77	285	38	<b>2500</b>
		Armoire ouverte - Classeur latéral, tablettes ajustables et 2 tiroirs filières.  <i>Open bookcase - lateral file, adjustable shelves and 2 filing drawers.</i>	<b>O5-12-18</b>	30	18	63	180	30	<b>2140</b>
			<b>O5-12M-18</b>	30	18	70	200	32	<b>2260</b>
			<b>O5-12H-18</b>	30	18	77	230	33	<b>2380</b>
			<b>O5-12-24</b>	30	24	63	200	33	<b>2240</b>
			<b>O5-12M-24</b>	30	24	70	210	34	<b>2360</b>
			<b>O5-12H-24</b>	30	24	77	240	34	<b>2490</b>
			<b>O5-12L-18</b>	36	18	63	220	32	<b>2240</b>
			<b>O5-12LM-18</b>	36	18	70	230	36	<b>2360</b>
			<b>O5-12LH-18</b>	36	18	77	250	36	<b>2490</b>
		Armoire fermée - Classeur latéral, tablettes ajustables et 2 tiroirs filières.  <i>Closed bookcase - lateral file, adjustable shelves and 2 filing drawers.</i>	<b>O5-13-18</b>	30	18	63	190	30	<b>2440</b>
			<b>O5-13M-18</b>	30	18	70	210	32	<b>2570</b>
			<b>O5-13H-18</b>	30	18	77	240	33	<b>2700</b>
			<b>O5-13-24</b>	30	24	63	210	33	<b>2540</b>
			<b>O5-13M-24</b>	30	24	70	220	34	<b>2670</b>
			<b>O5-13H-24</b>	30	24	77	250	34	<b>2810</b>
			<b>O5-13L-18</b>	36	18	63	230	32	<b>2540</b>
			<b>O5-13LM-18</b>	36	18	70	240	36	<b>2670</b>
			<b>O5-13LH-18</b>	36	18	77	260	36	<b>2810</b>
		Armoire semi-ouverte avec porte coulissante - Classeur latéral, tablettes ajustables et 2 tiroirs filières.  <i>Half - Closed bookcase with sliding door, lateral file, adjustable shelves and 2 filing drawers.</i>	<b>O5-13PC-18</b>	30	18	63	190	30	<b>2600</b>
			<b>O5-13PCM-18</b>	30	18	70	210	32	<b>2730</b>
			<b>O5-13PCH-18</b>	30	18	77	240	33	<b>2860</b>
			<b>O5-13PC-24</b>	30	24	63	210	33	<b>2700</b>
			<b>O5-13PCM-24</b>	30	24	70	220	34	<b>2830</b>
			<b>O5-13PCH-24</b>	30	24	77	250	34	<b>2970</b>
			<b>O5-13PCL-18</b>	36	18	63	230	32	<b>2700</b>
			<b>O5-13PCLM-18</b>	36	18	70	240	36	<b>2830</b>
			<b>O5-13PCLH-18</b>	36	18	77	260	36	<b>2970</b>
			<b>O5-13PCL-24</b>	36	24	63	240	36	<b>2800</b>
			<b>O5-13PCLM-24</b>	36	24	70	250	38	<b>2940</b>
			<b>O5-13PCLH-24</b>	36	24	77	280	40	<b>3080</b>

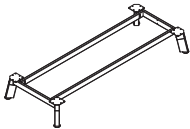
MODÈLE MODEL	DESCRIPTION	CODE	LARG. WIDTH "	PROF. DEPTH "	HAUT. HEIGHT "	POIDS WEIGHT LBS LBS	VOLUME VOLUME PI <sup>3</sup> FT <sup>3</sup>	PRIX PRICE \$
	Base pour modules 18".	<b>O5-BASE-4818-M-</b> _	48	18	7 1/2			<b>630</b>
	<i>Base for 18" modules.</i>	<b>O5-BASE-5418-M-</b> _	54	18	7 1/2			<b>635</b>
		<b>O5-BASE-6018-M-</b> _	60	18	7 1/2			<b>640</b>
		<b>O5-BASE-7218-M-</b> _	72	18	7 1/2			<b>660</b>
		<b>O5-BASE-7818-M-</b> _	78	18	7 1/2			<b>670</b>
		<b>O5-BASE-8418-M-</b> _	84	18	7 1/2			<b>680</b>
		<b>O5-BASE-9018-M-</b> _	90	18	7 1/2			<b>690</b>

Pour les pattes en bois, ajouter **80\$** au prix et remplacez le **-M** par **-W** dans le code.  
For wood legs, add **80\$** to the price and replace **-M** by **-W** to the product code.

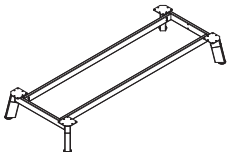
	Base pour modules 30".	<b>O5-BASE-4830-M-</b> _	48	30	7 1/2			<b>670</b>
	<i>Base for 30" modules.</i>	<b>O5-BASE-5430-M-</b> _	54	30	7 1/2			<b>675</b>
		<b>O5-BASE-6030-M-</b> _	60	30	7 1/2			<b>680</b>
		<b>O5-BASE-7230-M-</b> _	72	30	7 1/2			<b>700</b>
		<b>O5-BASE-7830-M-</b> _	78	30	7 1/2			<b>710</b>
		<b>O5-BASE-8430-M-</b> _	84	30	7 1/2			<b>720</b>
		<b>O5-BASE-9030-M-</b> _	90	30	7 1/2			<b>730</b>

Pour les pattes en bois, ajouter **80\$** au prix et remplacez le **-M** par **-W** dans le code.  
For wood legs, add **80\$** to the price and replace **-M** by **-W** to the product code.

	Patte unitaire de métal. avec réceptable et niveleur.	<b>O5-LEG-M-</b> _			7 1/2			<b>80</b>
	<i>Single metal leg with receptable and glide.</i>							

	Patte unitaire en bois. avec réceptable et niveleur.	<b>O5-LEG-W-</b> _			7 1/2			<b>100</b>
	<i>Single wood leg with receptable and glide.</i>							

Les bases sont prévu pour recevoir des modules de rangement superposables qui seront commandés séparément selon leur position. Choix de pattes de métal blanc (**-B**), noir (**-N**), argent (**-S**) ou en bois, disponible dans plusieurs finis.

Bases are made for receiving the stackable storage modules that can be ordered separately according to their position. Choice of metal legs available in white (**-B**), black (**-N**) and silver (**-S**) or in wood, available in many different finishes.

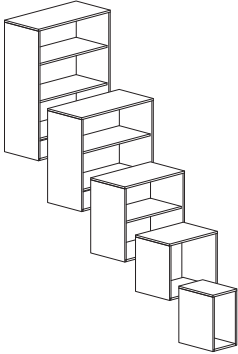
MODÈLE MODEL	DESCRIPTION	CODE	LARG. WIDTH "	PROF. DEPTH "	HAUT HEIGHT "	POIDS WEIGHT LBS LBS	VOLUME VOLUME PI <sup>3</sup> FT <sup>3</sup>	BOIS WOOD \$
	Module d'armoire ouverte superposable.  <i>Stackable open bookcase module.</i>	<b>05-ST-SO-1221-15</b>	12	15	21	20	3	<b>670</b>
		<b>05-ST-SO-1228-15</b>	12	15	28	23	3	<b>710</b>
		<b>05-ST-SO-1235-15</b>	12	15	35	25	5	<b>750</b>
		<b>05-ST-SO-1242-15</b>	12	15	42	27	6	<b>810</b>
		<b>05-ST-SO-1249-15</b>	12	15	49	29	6	<b>900</b>
		<b>05-ST-SO-1256-15</b>	12	15	56	30	7	<b>920</b>
		<b>05-ST-SO-1821-15</b>	18	15	21	23	5	<b>690</b>
		<b>05-ST-SO-1828-15</b>	18	15	28	26	5	<b>730</b>
		<b>05-ST-SO-1835-15</b>	18	15	35	28	7	<b>770</b>
		<b>05-ST-SO-1842-15</b>	18	15	42	30	9	<b>830</b>
		<b>05-ST-SO-1849-15</b>	18	15	49	32	9	<b>920</b>
		<b>05-ST-SO-1856-15</b>	18	15	56	33	11	<b>940</b>
		<b>05-ST-SO-2421-15</b>	24	15	21	25	6	<b>760</b>
		<b>05-ST-SO-2428-15</b>	24	15	28	28	6	<b>780</b>
		<b>05-ST-SO-2435-15</b>	24	15	35	30	9	<b>810</b>
		<b>05-ST-SO-2442-15</b>	24	15	42	32	10	<b>860</b>
		<b>05-ST-SO-2449-15</b>	24	15	49	34	12	<b>940</b>
		<b>05-ST-SO-2456-15</b>	24	15	56	35	13	<b>980</b>
		<b>05-ST-SO-3021-15</b>	30	15	21	28	9	<b>820</b>
		<b>05-ST-SO-3028-15</b>	30	15	28	31	9	<b>840</b>
		<b>05-ST-SO-3035-15</b>	30	15	35	33	11	<b>860</b>
		<b>05-ST-SO-3042-15</b>	30	15	42	35	13	<b>880</b>
		<b>05-ST-SO-3049-15</b>	30	15	49	37	15	<b>960</b>
		<b>05-ST-SO-3056-15</b>	30	15	56	38	17	<b>1020</b>
	<b>05-ST-SO-3621-15</b>	36	15	21	30	9	<b>930</b>	
	<b>05-ST-SO-3628-15</b>	36	15	28	33	9	<b>950</b>	
	<b>05-ST-SO-3635-15</b>	36	15	35	35	14	<b>970</b>	
	<b>05-ST-SO-3642-15</b>	36	15	42	37	16	<b>990</b>	
	<b>05-ST-SO-3649-15</b>	36	15	49	40	18	<b>1050</b>	
	<b>05-ST-SO-3656-15</b>	36	15	56	42	20	<b>1110</b>	
	<b>05-ST-SO-1221-18</b>	12	18	21	20	3	<b>700</b>	
	<b>05-ST-SO-1228-18</b>	12	18	28	23	3	<b>740</b>	
	<b>05-ST-SO-1235-18</b>	12	18	35	25	5	<b>790</b>	
	<b>05-ST-SO-1242-18</b>	12	18	42	27	6	<b>850</b>	
	<b>05-ST-SO-1249-18</b>	12	18	49	29	6	<b>940</b>	
	<b>05-ST-SO-1256-18</b>	12	18	56	30	7	<b>970</b>	
	<b>05-ST-SO-1821-18</b>	18	18	21	23	5	<b>720</b>	
	<b>05-ST-SO-1828-18</b>	18	18	28	26	5	<b>770</b>	
	<b>05-ST-SO-1835-18</b>	18	18	35	28	7	<b>810</b>	
	<b>05-ST-SO-1842-18</b>	18	18	42	30	9	<b>870</b>	
	<b>05-ST-SO-1849-18</b>	18	18	49	32	9	<b>970</b>	
	<b>05-ST-SO-1856-18</b>	18	18	56	33	11	<b>990</b>	
	<b>05-ST-SO-2421-18</b>	24	18	21	25	6	<b>800</b>	
	<b>05-ST-SO-2428-18</b>	24	18	28	28	6	<b>820</b>	
	<b>05-ST-SO-2435-18</b>	24	18	35	30	9	<b>850</b>	
	<b>05-ST-SO-2442-18</b>	24	18	42	32	10	<b>900</b>	
	<b>05-ST-SO-2449-18</b>	24	18	49	34	12	<b>990</b>	
	<b>05-ST-SO-2456-18</b>	24	18	56	35	13	<b>1030</b>	
	<b>05-ST-SO-3021-18</b>	30	18	21	38	9	<b>860</b>	
	<b>05-ST-SO-3028-18</b>	30	18	28	31	9	<b>880</b>	
	<b>05-ST-SO-3035-18</b>	30	18	35	33	11	<b>900</b>	
	<b>05-ST-SO-3042-18</b>	30	18	42	35	13	<b>920</b>	
	<b>05-ST-SO-3049-18</b>	30	18	49	37	15	<b>1010</b>	
	<b>05-ST-SO-3056-18</b>	30	18	56	38	17	<b>1070</b>	
	<b>05-ST-SO-3621-18</b>	36	18	21	30	9	<b>980</b>	
	<b>05-ST-SO-3628-18</b>	36	18	28	33	9	<b>1000</b>	
	<b>05-ST-SO-3635-18</b>	36	18	35	35	14	<b>1020</b>	
	<b>05-ST-SO-3642-18</b>	36	18	42	37	16	<b>1040</b>	
	<b>05-ST-SO-3649-18</b>	36	18	49	40	18	<b>1100</b>	
	<b>05-ST-SO-3656-18</b>	36	18	56	42	20	<b>1200</b>	

Les modules superposables peuvent être installés sur le système de bases Office 5 (voir p.28). Seuls les modules de 15" de profondeur peuvent être fixés au mur.

*Stackable modules can be installed on the Office 5 base system. Only 15" deep modules can be wallmounted.*

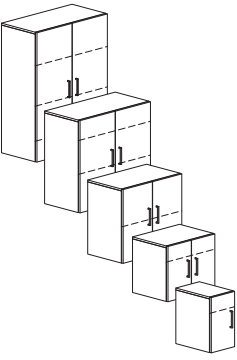
MODÈLE MODEL	DESCRIPTION	CODE	LARG. WIDTH "	PROF. DEPTH "	HAUT HEIGHT "	POIDS WEIGHT LBS LBS	VOLUME VOLUME PI <sup>3</sup> FT <sup>3</sup>	BOIS WOOD \$
	Module d'armoire fermée superposable avec portes	<b>O5-ST-SD-1221-15</b>	12	15	21	25	3	<b>820</b>
		<b>O5-ST-SD-1228-15</b>	12	15	28	28	3	<b>860</b>
	<i>Stackable closed bookcase module with hinged doors.</i>	<b>O5-ST-SD-1235-15</b>	12	15	35	30	5	<b>910</b>
		<b>O5-ST-SD-1242-15</b>	12	15	42	32	6	<b>970</b>
		<b>O5-ST-SD-1249-15</b>	12	15	49	34	6	<b>1080</b>
		<b>O5-ST-SD-1256-15</b>	12	15	56	35	7	<b>1100</b>
		<b>O5-ST-SD-1821-15</b>	18	15	21	28	5	<b>840</b>
		<b>O5-ST-SD-1828-15</b>	18	15	28	31	5	<b>880</b>
		<b>O5-ST-SD-1835-15</b>	18	15	35	33	7	<b>930</b>
		<b>O5-ST-SD-1842-15</b>	18	15	42	35	9	<b>990</b>
<b>O5-ST-SD-1849-15</b>	18	15	49	37	9	<b>1100</b>		
<b>O5-ST-SD-1856-15</b>	18	15	56	38	11	<b>1120</b>		
<b>O5-ST-SD-2421-15</b>	24	15	21	32	6	<b>1100</b>		
<b>O5-ST-SD-2428-15</b>	24	15	28	35	6	<b>1120</b>		
<b>O5-ST-SD-2435-15</b>	24	15	35	37	9	<b>1150</b>		
<b>O5-ST-SD-2442-15</b>	24	15	42	39	10	<b>1200</b>		
<b>O5-ST-SD-2449-15</b>	24	15	49	41	12	<b>1280</b>		
<b>O5-ST-SD-2456-15</b>	24	15	56	42	13	<b>1320</b>		
<b>O5-ST-SD-3021-15</b>	30	15	21	38	9	<b>1200</b>		
<b>O5-ST-SD-3028-15</b>	30	15	28	41	9	<b>1220</b>		
<b>O5-ST-SD-3035-15</b>	30	15	35	43	11	<b>1240</b>		
<b>O5-ST-SD-3042-15</b>	30	15	42	45	13	<b>1260</b>		
<b>O5-ST-SD-3049-15</b>	30	15	49	47	15	<b>1340</b>		
<b>O5-ST-SD-3056-15</b>	30	15	56	48	17	<b>1400</b>		
<b>O5-ST-SD-3621-15</b>	36	15	21	40	9	<b>1310</b>		
<b>O5-ST-SD-3628-15</b>	36	15	28	43	9	<b>1330</b>		
<b>O5-ST-SD-3635-15</b>	36	15	35	55	14	<b>1350</b>		
<b>O5-ST-SD-3642-15</b>	36	15	42	57	16	<b>1370</b>		
<b>O5-ST-SD-3649-15</b>	36	15	49	60	18	<b>1430</b>		
<b>O5-ST-SD-3656-15</b>	36	15	56	62	20	<b>1490</b>		
<b>O5-ST-SD-1221-18</b>	12	18	21	25	3	<b>850</b>		
<b>O5-ST-SD-1228-18</b>	12	18	28	28	3	<b>900</b>		
<b>O5-ST-SD-1235-18</b>	12	18	35	30	5	<b>950</b>		
<b>O5-ST-SD-1242-18</b>	12	18	42	32	6	<b>1010</b>		
<b>O5-ST-SD-1249-18</b>	12	18	49	34	6	<b>1120</b>		
<b>O5-ST-SD-1256-18</b>	12	18	56	35	7	<b>1150</b>		
<b>O5-ST-SD-1821-18</b>	18	18	21	28	5	<b>870</b>		
<b>O5-ST-SD-1828-18</b>	18	18	28	31	5	<b>920</b>		
<b>O5-ST-SD-1835-18</b>	18	18	35	33	7	<b>970</b>		
<b>O5-ST-SD-1842-18</b>	18	18	42	35	9	<b>1030</b>		
<b>O5-ST-SD-1849-18</b>	18	18	49	37	9	<b>1150</b>		
<b>O5-ST-SD-1856-18</b>	18	18	56	38	11	<b>1170</b>		
<b>O5-ST-SD-2421-18</b>	24	18	21	32	6	<b>1140</b>		
<b>O5-ST-SD-2428-18</b>	24	18	28	35	6	<b>1160</b>		
<b>O5-ST-SD-2435-18</b>	24	18	35	37	9	<b>1180</b>		
<b>O5-ST-SD-2442-18</b>	24	18	42	39	10	<b>1240</b>		
<b>O5-ST-SD-2449-18</b>	24	18	49	41	12	<b>1330</b>		
<b>O5-ST-SD-2456-18</b>	24	18	56	42	13	<b>1370</b>		
<b>O5-ST-SD-3021-18</b>	30	18	21	38	9	<b>1240</b>		
<b>O5-ST-SD-3028-18</b>	30	18	28	41	9	<b>1260</b>		
<b>O5-ST-SD-3035-18</b>	30	18	35	43	11	<b>1280</b>		
<b>O5-ST-SD-3042-18</b>	30	18	42	45	13	<b>1300</b>		
<b>O5-ST-SD-3049-18</b>	30	18	49	47	15	<b>1390</b>		
<b>O5-ST-SD-3056-18</b>	30	18	56	48	17	<b>1450</b>		
<b>O5-ST-SD-3621-18</b>	36	18	21	40	9	<b>1360</b>		
<b>O5-ST-SD-3628-18</b>	36	18	28	43	9	<b>1380</b>		
<b>O5-ST-SD-3635-18</b>	36	18	35	55	14	<b>1400</b>		
<b>O5-ST-SD-3642-18</b>	36	18	42	57	16	<b>1420</b>		
<b>O5-ST-SD-3649-18</b>	36	18	49	60	18	<b>1480</b>		
<b>O5-ST-SD-3656-18</b>	36	18	56	62	20	<b>1580</b>		

Le modules superposables peuvent être installés sur le système de bases Office 5 (voir p.28). Seuls les modules de 15" de profondeur peuvent être fixés au mur.

*Stackable modules can be installed on the Office 5 base system. Only 15" deep modules can be wallmounted.*

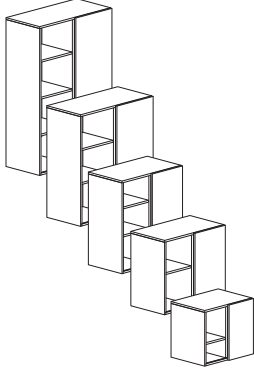
MODÈLE MODEL	DESCRIPTION	CODE	LARG. WIDTH "	PROF. DEPTH "	HAUT HEIGHT "	POIDS WEIGHT LBS LBS	VOLUME VOLUME PI <sup>3</sup> FT <sup>3</sup>	BOIS WOOD \$
	Module d'armoire semi-ouverte superposable avec porte coulissante.  <i>Stackable half-closed bookcase module with sliding door.</i>	<b>O5-ST-SDPC-2421-15</b>	24	15	21	32	6	<b>1260</b>
		<b>O5-ST-SDPC-2428-15</b>	24	15	28	35	6	<b>1280</b>
		<b>O5-ST-SDPC-2435-15</b>	24	15	35	37	9	<b>1310</b>
		<b>O5-ST-SDPC-2442-15</b>	24	15	42	39	10	<b>1360</b>
		<b>O5-ST-SDPC-2449-15</b>	24	15	49	41	12	<b>1440</b>
		<b>O5-ST-SDPC-2456-15</b>	24	15	56	42	13	<b>1480</b>
		<b>O5-ST-SDPC-3021-15</b>	30	15	21	38	9	<b>1360</b>
		<b>O5-ST-SDPC-3028-15</b>	30	15	28	41	9	<b>1380</b>
		<b>O5-ST-SDPC-3035-15</b>	30	15	35	43	11	<b>1400</b>
		<b>O5-ST-SDPC-3042-15</b>	30	15	42	45	13	<b>1420</b>
<b>O5-ST-SDPC-3049-15</b>	30	15	49	47	15	<b>1500</b>		
<b>O5-ST-SDPC-3056-15</b>	30	15	56	48	17	<b>1560</b>		
<b>O5-ST-SDPC-3621-15</b>	36	15	21	40	9	<b>1470</b>		
<b>O5-ST-SDPC-3628-15</b>	36	15	28	43	9	<b>1490</b>		
<b>O5-ST-SDPC-3635-15</b>	36	15	35	55	14	<b>1510</b>		
<b>O5-ST-SDPC-3642-15</b>	36	15	42	57	16	<b>1530</b>		
<b>O5-ST-SDPC-3649-15</b>	36	15	49	60	18	<b>1590</b>		
<b>O5-ST-SDPC-3656-15</b>	36	15	56	62	20	<b>1650</b>		
<b>O5-ST-SDPC-2421-18</b>	24	18	21	32	6	<b>1300</b>		
<b>O5-ST-SDPC-2428-18</b>	24	18	28	35	6	<b>1320</b>		
<b>O5-ST-SDPC-2435-18</b>	24	18	35	37	9	<b>1340</b>		
<b>O5-ST-SDPC-2442-18</b>	24	18	42	39	10	<b>1400</b>		
<b>O5-ST-SDPC-2449-18</b>	24	18	49	41	12	<b>1490</b>		
<b>O5-ST-SDPC-2456-18</b>	24	18	56	42	13	<b>1530</b>		
<b>O5-ST-SDPC-3021-18</b>	30	18	21	38	9	<b>1400</b>		
<b>O5-ST-SDPC-3028-18</b>	30	18	28	41	9	<b>1420</b>		
<b>O5-ST-SDPC-3035-18</b>	30	18	35	43	11	<b>1440</b>		
<b>O5-ST-SDPC-3042-18</b>	30	18	42	45	13	<b>1460</b>		
<b>O5-ST-SDPC-3049-18</b>	30	18	49	47	15	<b>1550</b>		
<b>O5-ST-SDPC-3056-18</b>	30	18	56	48	17	<b>1610</b>		
<b>O5-ST-SDPC-3621-18</b>	36	18	21	40	9	<b>1520</b>		
<b>O5-ST-SDPC-3628-18</b>	36	18	28	43	9	<b>1540</b>		
<b>O5-ST-SDPC-3635-18</b>	36	18	35	55	14	<b>1560</b>		
<b>O5-ST-SDPC-3642-18</b>	36	18	42	57	16	<b>1580</b>		
<b>O5-ST-SDPC-3649-18</b>	36	18	49	60	18	<b>1640</b>		
<b>O5-ST-SDPC-3656-18</b>	36	18	56	62	20	<b>1740</b>		

Les modules superposables peuvent être installés sur le système de bases Office 5 (voir p.28). Seuls les modules de 15" de profondeur peuvent être fixés au mur.

*Stackable modules can be installed on the Office 5 base system. Only 15" deep modules can be wallmounted.*

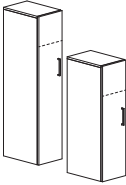
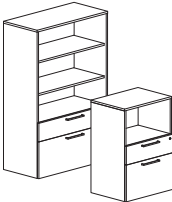
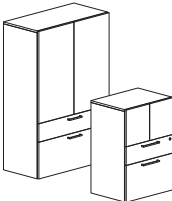
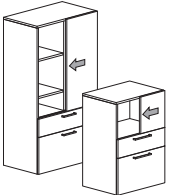
MODÈLE MODEL	DESCRIPTION	CODE	LARG. WIDTH "	PROF. DEPTH "	HAUT HEIGHT "	POIDS WEIGHT LBS LBS	VOLUME VOLUME PI <sup>3</sup> FT <sup>3</sup>	BOIS WOOD \$
	Demi-armoire penderie superposable, gauche.	<b>O5-ST-1SL-1242</b>	12	18	42	32	6	<b>1010</b>
	Pour demie-penderie droite (O5-ST-1SR-18)	<b>O5-ST-1SL-1249</b>	12	18	49	34	6	<b>1120</b>
		<b>O5-ST-1SL-1256</b>	12	18	56	35	7	<b>1150</b>
	<i>Left stackable half-wardrobe.</i>	<b>O5-ST-1SL-1842</b>	18	18	42	35	9	<b>1030</b>
	<i>For half right wardrobe (O5-ST-1SR-18).</i>	<b>O5-ST-1SL-1849</b>	18	18	49	37	9	<b>1150</b>
		<b>O5-ST-1SL-1856</b>	18	18	56	38	11	<b>1170</b>
	Module d'armoire ouverte, superposable avec tiroirs utilité-killière.	<b>O5-O13-2428-18</b>	24	18	28	150	7	<b>1770</b>
		<b>O5-O13-2435-18</b>	24	18	35	160	9	<b>1810</b>
		<b>O5-O13-2442-18</b>	24	18	42	170	11	<b>1880</b>
		<b>O5-O13-2449-18</b>	24	18	49	175	12	<b>1900</b>
		<b>O5-O13-2456-18</b>	24	18	56	180	14	<b>1920</b>
	<i>Stackable open storage module with box-file drawers.</i>	<b>O5-O13-3028-18</b>	30	18	28	155	9	<b>1860</b>
		<b>O5-O13-3035-18</b>	30	18	35	165	12	<b>1900</b>
		<b>O5-O13-3042-18</b>	30	18	42	175	13	<b>1980</b>
		<b>O5-O13-3049-18</b>	30	18	49	180	15	<b>2000</b>
		<b>O5-O13-3056-18</b>	30	18	56	185	18	<b>2020</b>
		<b>O5-O13-3628-18</b>	36	18	28	160	11	<b>1960</b>
		<b>O5-O13-3635-18</b>	36	18	35	170	14	<b>2000</b>
		<b>O5-O13-3642-18</b>	36	18	42	180	16	<b>2080</b>
	<b>O5-O13-3649-18</b>	36	18	49	185	18	<b>2100</b>	
	<b>O5-O13-3656-18</b>	36	18	56	190	21	<b>2120</b>	
	Module d'armoire fermée, superposable avec portes à charnière et tiroirs utilité-killière.	<b>O5-C13-2428-18</b>	24	18	28	160	7	<b>2070</b>
		<b>O5-C13-2435-18</b>	24	18	35	170	9	<b>2110</b>
		<b>O5-C13-2442-18</b>	24	18	42	180	11	<b>2200</b>
		<b>O5-C13-2449-18</b>	24	18	49	185	12	<b>2230</b>
		<b>O5-C13-2456-18</b>	24	18	56	190	14	<b>2250</b>
	<i>Stackable closed storage module with hinged doors and box-file drawers.</i>	<b>O5-C13-3028-18</b>	30	18	28	160	9	<b>2160</b>
		<b>O5-C13-3035-18</b>	30	18	35	170	12	<b>2200</b>
		<b>O5-C13-3042-18</b>	30	18	42	180	13	<b>2300</b>
		<b>O5-C13-3049-18</b>	30	18	49	185	15	<b>2330</b>
		<b>O5-C13-3056-18</b>	30	18	56	190	18	<b>2350</b>
		<b>O5-C13-3628-18</b>	36	18	28	170	11	<b>2260</b>
		<b>O5-C13-3635-18</b>	36	18	35	180	14	<b>2300</b>
		<b>O5-C13-3642-18</b>	36	18	42	190	16	<b>2400</b>
	<b>O5-C13-3649-18</b>	36	18	49	195	18	<b>2430</b>	
	<b>O5-C13-3656-18</b>	36	18	56	200	21	<b>2450</b>	
	Module d'armoire semi-ouverte, superposable avec porte coulissante et tiroirs utilité-killière.	<b>O5-PC13-2428-18</b>	24	18	28	160	7	<b>2230</b>
		<b>O5-PC13-2435-18</b>	24	18	35	170	9	<b>2270</b>
		<b>O5-PC13-2442-18</b>	24	18	42	180	11	<b>2380</b>
		<b>O5-PC13-2449-18</b>	24	18	49	185	12	<b>2390</b>
		<b>O5-PC13-2456-18</b>	24	18	56	190	14	<b>2410</b>
	<i>Stackable half-closed storage module with sliding door and box-file drawers.</i>	<b>O5-PC13-3028-18</b>	30	18	28	160	9	<b>2320</b>
		<b>O5-PC13-3035-18</b>	30	18	35	170	12	<b>2360</b>
		<b>O5-PC13-3042-18</b>	30	18	42	180	13	<b>2460</b>
		<b>O5-PC13-3049-18</b>	30	18	49	185	15	<b>2490</b>
		<b>O5-PC13-3056-18</b>	30	18	56	190	18	<b>2510</b>
		<b>O5-PC13-3628-18</b>	36	18	28	170	11	<b>2420</b>
		<b>O5-PC13-3635-18</b>	36	18	35	180	14	<b>2460</b>
		<b>O5-PC13-3642-18</b>	36	18	42	190	16	<b>2560</b>
	<b>O5-PC13-3649-18</b>	36	18	49	195	18	<b>2590</b>	
	<b>O5-PC13-3656-18</b>	36	18	56	200	21	<b>2610</b>	

Le modules superposables peuvent être installés sur le système de bases Office 5 (voir p.28). Seuls les modules de 15" de profondeur peuvent être fixés au mur.

*Stackable modules can be installed on the Office 5 base system. Only 15" deep modules can be wallmounted.*



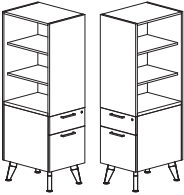
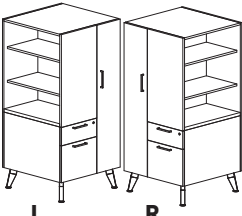
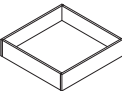
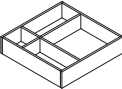
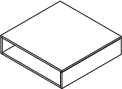
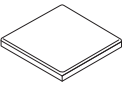

MODÈLE MODEL	DESCRIPTION	CODE	LARG. WIDTH "	PROF. DEPTH "	HAUT HEIGHT "	POIDS WEIGHT LBS LBS	VOLUME VOLUME PI <sup>3</sup> FT <sup>3</sup>	MÉLAMINE LAMINATE \$	BOIS WOOD \$
 L R	Tour latérale sur pattes avec caisson utilité et armoire latérale ouverte gauche.  <i>Lateral tower on legs with filing pedestal and open lateral bookcase.</i>	<b>O5-ST-18LC-24-</b> _	18	24	56	140	22		<b>2030</b>
		<b>O5-ST-18LC-30-</b> _	18	30	56	150	24		<b>2120</b>
		<b>O5-ST-18LHC-24-</b> _	18	24	63	155	25		<b>2080</b>
		<b>O5-ST-18LHC-30-</b> _	18	30	63	165	27		<b>2180</b>
		<b>O5-ST-18RC-24-</b> _	18	24	56	140	22		<b>2030</b>
		<b>O5-ST-18RC-30-</b> _	18	30	56	150	24		<b>2120</b>
 L R	Tour latérale penderie sur pattes avec caisson utilité et armoire latérale ouverte gauche.  <i>Lateral tower-wardrobe on legs with utility pedestal and left open lateral bookcase.</i>	<b>O5-ST-30LC-24-</b> _	30	24	56	210	34		<b>3380</b>
		<b>O5-ST-30LC-30-</b> _	30	30	56	230	36		<b>3540</b>
		<b>O5-ST-30LHC-24-</b> _	30	24	63	230	40		<b>3430</b>
		<b>O5-ST-30LHC-30-</b> _	30	30	63	250	42		<b>3620</b>
		<b>O5-ST-30RC-24-</b> _	30	24	56	210	34		<b>3380</b>
		<b>O5-ST-30RC-30-</b> _	30	30	56	230	36		<b>3540</b>
	Bac à fleur, 7" H. <i>Planter, 7" H.</i>	<b>O5-PLTR-2418</b>	24	18	7			<b>300</b>	<b>450</b>
		<b>O5-PLTR-3018</b>	30	18	7			<b>310</b>	<b>470</b>
		<b>O5-PLTR-2430</b>	24	30	7			<b>320</b>	<b>480</b>
		<b>O5-PLTR-3030</b>	30	30	7			<b>340</b>	<b>510</b>
	Table de bout avec rangement, 7" H. <i>End Table with storage, 7" H.</i>	<b>O5-OT-F-2430</b>	24	30	7			<b>330</b>	<b>490</b>
		<b>O5-OT-F-3030</b>	30	30	7			<b>350</b>	<b>530</b>
	Table à revues, 7" H. <i>Magazine table, 7" H.</i>	<b>O5-OT-MAG-2430</b>	24	30	7			<b>330</b>	<b>490</b>
		<b>O5-OT-MAG-3030</b>	30	30	7			<b>350</b>	<b>530</b>
	Coussin visiteur. Tissu Gr. 1 ou C.O.M.  <i>Visitor cushion. Fabric Grade 1 or C.O.M.</i>	<b>O5-SEAT-3618</b>	36	18	2				<b>325</b>
		<b>O5-SEAT-3018</b>	30	18	2				<b>325</b>

Les pattes des modules superposables sont disponibles en bois (-W) ou en métal (-M). Veuillez spécifier votre choix en insérant la lettre appropriée au code et spécifier le fini désiré.

*Legs for stackable modules are available in wood (-W) or metal (-M). Please specify your selection by inserting the appropriate letter in the code and desired finish.*

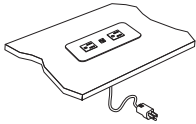

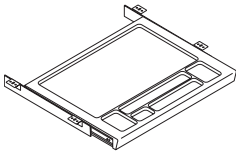
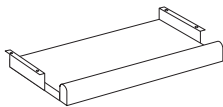
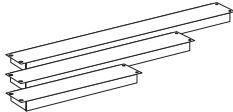
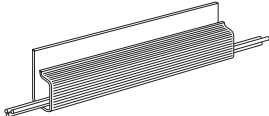
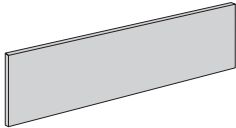
MODÈLE MODEL	DESCRIPTION	CODE	LARG. WIDTH "	PROF. DEPTH "	HAUT HEIGHT "	POIDS WEIGHT LBS LBS	VOLUME VOLUME PI <sup>3</sup> FT <sup>3</sup>	BOIS WOOD \$
	2 simplexes et prise USB double. Fini aluminium brossé.  <i>2 simplex and double USB port. Brushed aluminium finish.</i>	<b>AC-ECC-2</b>	2 1/2		5 3/4			<b>525</b>
	Capuchon de filerie. Plastique noir.  <i>Grommet. Black plastic.</i>	<b>AC-LWC-1</b>			2 3/8 dia.			<b>50</b>
		<b>AC-LWC-2</b>			3 1/8 dia.			<b>50</b>
	Tiroir central compartimenté.  <i>Molded center drawer.</i>	<b>AC-CD</b>		22	18	1 1/2	10	<b>360</b>
	Tablette coulissante pour clavier. Finis : noir ( <b>CS</b> ) bois ( <b>CSW</b> )  <i>Keyboard drawer. Finishes : black (<b>CS</b>) wood (<b>CSW</b>)</i>	<b>AC-CS-22</b>	23	11	3	10		<b>220</b>
		<b>AC-CS-28</b>	23-29	11	3	11		<b>360</b>
		<b>AC-CSW-22</b>	22	12	3	10		<b>440</b>
		<b>AC-CSW-28</b>	28	12	3	11		<b>520</b>
	Lampe de travail DEL. Fil de 9'. Fini argent.  <i>LED task light. 9' cord. Silver finish.</i>	<b>AC-LED-24</b>	24 1/2	3 1/2	1 1/4			<b>210</b>
		<b>AC-LED-36</b>	36 1/2	3 1/2	1 1/4			<b>290</b>
		<b>AC-LED-48</b>	48 1/2	3 1/2	1 1/4			<b>310</b>
	Gaine électrique horizontale. Section de 36".  <i>Horizontal wire manager racetrack. 36" section.</i>	<b>AC-WMRH</b>	36	1	1 1/2			<b>40</b>
	Babillard pour huches. Prix pour tissu Grade 1 et C.O.M. Spécifiez le type de huches.  <i>Tackboard for overhead cabinets. Price for Grade 1 and C.O.M. fabric. Specify the type of overhead cabinet.</i>	<b>AC-TK-84</b>	84	1	23			<b>495</b>
		<b>AC-TK-78</b>	78	1	23			<b>475</b>
		<b>AC-TK-72</b>	72	1	23			<b>440</b>
		<b>AC-TK-60</b>	60	1	23			<b>420</b>
		<b>AC-TK-48</b>	48	1	23			<b>400</b>
		<b>AC-TK-36</b>	36	1	23			<b>350</b>
		<b>AC-TK-2414</b>	24	1	14			<b>300</b>

Choix de pattes ou de base de métal blanc (-B), noir (-N), argent (-S).  
Choice of metal legs ou base available in white (-B), black (-N) and silver (-S).

---

---

**Prix et termes**

Les prix indiqués sont des prix de détail suggérés, F.A.B. notre usine, et sont sujets à changement sans préavis. Ils sont fermes et définitifs après l'acceptation de la commande.

Les conditions : net 30 (trente) jours après la date de la facturation. Si les termes ne sont pas respectés, ceci engendrera une perte de cote de crédit et entraînera les frais de collection encourus. Profil Plus se réserve le droit d'exiger un dépôt avec la commande ou avant la livraison de la marchandise.

Un dépôt de 50% est requis pour tout item non standard.

**Commandes**

Toute commande est sujette à l'approbation de Profil Plus et est considérée finale. Les confirmations de commande liant les parties confirment les prix, les termes et les dates de livraison anticipées.

**Changements et annulations**

Tout changement à une commande ou annulation doit être fait par écrit et est sujet à notre approbation. Profil Plus se réserve le droit de facturer 25% pour la partie de commande déjà exécutée. Tout changement à une commande retardera les délais de livraison. Les commandes en tissu ou finis non-standard ne peuvent être annulées.

**Entreposage**

Des frais d'entreposage seront appliqués pour tout article non reçu par le client une semaine après la date prévue pour la livraison.

**Expéditions**

Les marchandises sont remises au transporteur en excellente condition. La responsabilité de Profil Plus cesse à partir de la prise en charge par le transporteur. Ce dernier sera choisi par Profil Plus à moins d'indication contraire. Les réclamations pour commandes incomplètes ou marchandise endommagée doivent être présentées directement à la compagnie de transport et doivent être inscrites sur votre copie de connaissance.

**Retour de marchandise**

Toute marchandise retournée pour réparation ou crédit doit nous parvenir port payé et accompagnée d'un numéro d'autorisation de retour. Si cette procédure n'est pas suivie, la marchandise ne sera pas acceptée à l'usine et sera réexpédiée à vos frais sans autre formalité. Dans le cas d'un défaut de fabrication, la réclamation doit être faite dans les 10 (dix) jours, et la marchandise doit nous parvenir dans les 15 (quinze) jours suivant la réception du numéro d'autorisation de retour.

**Entrée des commandes**

Pour nous faciliter l'entrée de commandes et accélérer la livraison, assurez-vous d'avoir tous les détails suivants :

- numéro de modèle complet
- quantité
- description
- couleur et fini
- échantillon de fini, si spéciale
- spécifications détaillées, si requises
- choix de tissus
- étiquetage
- prix
- informations pour livraison et/ou installation

**Prices and terms**

All prices shown are list prices, F.O.B. our factory, and are subject to changes without prior notice. They are firm and final after acceptance of the order. Terms are net 30 (thirty) days after invoicing date. Credit will be offered only to accredited buyers with good credit references. Failure to meet terms will result in loss of credit terms and collection cost of an attorney. Profil Plus reserves the right to require a deposit with order or before shipment of the merchandise.

**Orders**

All orders are subject to acceptance by Profil Plus and are considered final. Our order confirmations are formally acknowledged confirming prices terms and anticipated delivery date.

**Changes and cancellations**

Changes to orders or cancellations may be made in writing and are subject to acceptance by Profil Plus. Profil Plus reserves the right to charge 25% for the work in process or a restocking charge. Any product modifications may warrant scheduling delays. Orders of non-standard fabric or finish cannot be cancelled once released to manufacturing.

**Storage**

Orders that are produced and ready for shipment will be placed in storage at customer's expense, one week after the expected delivery date. Profil Plus is not responsible for storage of products due to delays at the customer site which is out of our control.

**Shipping**

All furniture is shipped in excellent condition. Profil Plus's responsibility stops when the goods are accepted by the carrier. The carrier is chosen by Profil Plus unless otherwise stated. All claims concerning incomplete orders or damage must be presented directly to the carrier and clearly noted on the shipping bill of lading.

**Returned goods**

Goods returned for repair or credit must be shipped to us on a prepaid basis and accompanied by a return authorization number. If this procedure is not followed, the merchandise will not be accepted at factory and will be returned at your cost. All claims concerning workmanship or defects must be done within 15 (fifteen) days following receipt of the return authorization number.

**Order entry**

To assist in processing your order, be assured that all information required is included on your purchase order:

- complete model number
- quantity per item
- description of item
- color and finish
- special finish sample, if required
- detailed specifications, if required
- fabric selection
- tagging information
- price
- shipping and/or installation information

**Informations générales**

Tous les produits de Profil Plus sont fabriqués avec des produits supérieurs. Profil Plus se réserve le droit de modifier les designs, les matériaux, la construction ou les dimensions sans préavis. Les poids et les volumes indiqués sont approximatifs.

**Spéciaux**

Bien que nous ayons un éventail de produits variés, nous offrons aussi des spéciaux pour des contrats spécifiques. Profil Plus est à votre disposition pour vous aider à réaliser ces projets.

**Finis**

La plupart de nos produits sont disponibles dans 21 (vingt-et-un) finis. Des finis spéciaux sont offerts moyennant un supplément. Les bois utilisés peuvent présenter des différences naturelles de veinage ou teinte.

**Garantie**

Tous les produits manufacturés par Profil Plus sont garantis contre tout vice de fabrication pour une période de 5 (cinq) ans. Les tissus, les finis et les roulettes sont garantis pour une période de 1 (un) an.

**General informations**

Profil Plus products are constructed of superior materials. Profil Plus reserves the right to make any changes in product design, materials, construction or dimensions of its products without prior notice. Weight and measures are approximate.

**Specials**

Although our product offering is comprehensive, special items and custom-made contracts are available. Profil Plus will assist you in securing these special projects.

**Finishes**

Most of our products are available in 21 (twenty-one) finishes. Special custom blended wood finishes are available on request, at extra charge. It should be noted that a difference can occur due to the variation in tone and color of select woods.

**Warranty**

All Profil Plus products are guaranteed for a period of five full years against defective materials and workmanship. Fabric, finish and casters are guaranteed for a period of one full year.

artelite.com

10251 BOUL. RAY LAWSON  
MONTREAL QC H1J 1L6  
CANADA  
T. 514 493 6113  
T. 800 737 5137

Printed in Canada

DESIGN & MARKETING :  
ALTER-E-GO SOLUTIONS

